

Midland
Syn-Tech III P25
Mobile Radio

OPERATION MANUAL

PREFACE

Thank you for purchasing a Midland Syn-Tech III P25 Mobile Radio. Properly used, this product will give you many years of reliable service. To get the most out of your purchase, be sure to carefully read this manual and keep it on hand for later reference when needed.



Before installing and using your radio, please read this operation manual.

CUSTOMER ASSISTANCE

Should you encounter any problems with this product, or are unable to use its features, please review this operation manual. If you require further assistance after reading this manual, please contact your local dealer.

FOR WARRANTY, PRODUCT SERVICE AND ACCESSORY INFORMATION

Please contact your local dealer or distributor.



Do not attempt to service any internal parts yourself. This radio should be opened by authorized personnel only.

Your radio is packed and labeled according to the commercial packaging standards.

IMPORTANT SAFETY INFORMATION



Before installing and using your radio, please read this operation manual.



GENERAL PRECAUTIONS

Always use only Midland authorized accessories.

Unauthorized accessories have the risk of fire hazard, explosion, personal injury or damage to the radio.



CAUTION

Changes or modifications to your radio may void its compliance with government laws/rules and make it illegal to use.

Avoid using the radio at temperatures below -30°C or above 60°C .

Avoid storing the radio at temperatures below -40°C or above 85°C .



WARNINGS

Your Midland Syn-Tech III P25 Mobile Radio generates electromagnetic RF energy when it is transmitting. To ensure that you and those around you are not exposed to excessive amounts of that energy (beyond recommended allowable limits for occupational use):

DO NOT operate your radio without a proper antenna. Otherwise, you can seriously damage your radio.

DO NOT touch the antenna when you are transmitting.

NEVER connect the transceiver to any AC power source. This may cause an electric shock or fire hazard and will damage your radio.

NEVER connect the transceiver to a DC power source either greater than 16 volts or with reverse polarity. Doing so will damage the transceiver.

DO NOT attempt to service any internal parts yourself. Please ask your dealer for necessary service. This radio should be opened by authorized personnel only.

Please read the installation and operating instructions carefully.

FCC EXPOSURE STATEMENTS



Restricted to occupational use to satisfy FCC RF energy exposure limits.

The FCC has adopted a safety standard for human exposure to RF energy. Proper operation of this radio under normal conditions results in user exposure to RF energy below the Occupational Safety and Health Act and Federal Communication Commission limits.

Mandatory Safety Instructions to Installers and Users:

This radio is **NOT** approved for use by the general population in an uncontrolled environment. This radio is restricted to occupational use and work related operations only. Radio operators must have the knowledge to control their exposure conditions and the exposure conditions of bystanders and/or passengers to satisfy the lower exposure limit allowed for General Population.

To comply with FCC RF exposure limits, **DO NOT** operate the transmitter of this mobile radio when a person outside the vehicle is within the minimum safe distance from the antenna:

- 50W VHF – 22 inches (56 centimeters)**
- 110W VHF – 31 inches (79 centimeters)**
- 40W UHF – 18 inches (45 centimeters)**

The antenna supplied by the manufacturer or radio dealer must be mounted at a location such that during radio transmission, no person or persons can come closer than the above indicated minimum safe distance to the antenna. To comply with current FCC RF exposure limits, the antenna must be installed at or exceeding the minimum safe distance stated above, and in accordance with the requirements of the antenna manufacturer or supplier.

Vehicle Installation Instructions:

The antenna used for this transmitter must be mounted on the center of the roof **ONLY** and must be installed in vehicle having the following characteristics in order to prevent bystanders and passengers from being exposed to levels exceeding the limits for General Population/Uncontrolled Exposure environment:

1. All passengers must be sitting under a solid metal roof.
2. For rear deck trunk and roof top installations, the antenna must be located at least the minimum safe distance away from rear-seat passengers and bystanders in order to comply with the FCC RF exposure requirements.

DO NOT operate the radio without the proper antenna installed. Do not substitute any antenna for the one supplied or recommended by the manufacturer or radio dealer. Antennas used for this transmitter must not exceed an antenna gain of 3 dBi. By not following the antenna recommendations you may be exposing person(s) to excess radio frequency radiation. You may contact your radio dealer or the manufacturer for further instructions.

DO NOT transmit more than 50% of total radio use time (50% duty cycle). Transmitting for more than 50% of the time can cause FCC RF exposure compliance requirements to be exceeded. This radio is transmitting whenever the Transmit/Receive LED is red. Pressing the PTT switch on the side of the microphone normally causes the radio to transmit.



The preceding information is provided to make you aware of RF exposure and how to ensure that this radio is operated within FCC RF exposure limits.

You, as the qualified end-user of this radio device must control the exposure conditions of bystanders to ensure the minimum separation distance, stated above for satisfying FCC RF exposure compliance, is maintained between the antenna and nearby persons. Transmit only when all person(s) are at least the minimum distance from the properly installed, externally mounted antenna.

PATENT AND COPYRIGHT STATEMENTS



The IMBE™ voice coding Technology embodied in this product is protected by intellectual property rights including patent rights, copyrights and trade secrets of Digital Voice Systems, Inc. This voice coding Technology is licensed solely for use within this Communications Equipment. The user of this Technology is explicitly prohibited from attempting to decompile, reverse engineer or disassemble the Object Code, or in any other way convert the Object Code into a human-readable form. U.S. Pat. Nos. #5,870,405, #5,826,222, #5,754,974, #5,701,390, #5,715,365, #5,649,050, #5,630,011, #5,581,656, #5,517,511, #5,491,772, #5,247,579, #5,226,084, and #5,195,166

PRODUCT FEATURES

Your Midland Syn-Tech III P25 Mobile Radio has the following features:

- 136-174 MHz VHF and 380-470 MHz UHF bands
- Mixed analog and digital mode operation
- Easy installation
- Low maintenance
- Tri-color LCD display
- Full keypad
- High quality audio
- User friendly interface
- Extensive user prompts, alerts and warnings
- Flexible accessory connections
- Microprocessor controlled
- DSP based audio
- Flash memory
- Synthesized frequency control
- Extensive use of surface mount technology
- PC controlled testing and alignment
- CTCSS/CDCSS sub-audible signaling
- 2-Tone / 5-Tone analog signaling
- Analog DTMF encoding
- Conforms with TIA/EIA-603-A standard in Analog Mode
- Conforms with TIA/EIA-102-CAAB standard in Digital Mode
- Conforms with APCO25 EIA / TIA 102 standards
- Conforms with MIL-STD-810E standards



Full technical specifications are given near the back of this manual.

ABBREVIATIONS AND ACRONYMS

ACK	: Acknowledge
AES	: Advanced Encryption Standard
ALG	: Algorithm
ANI	: Automatic Number Identification
dBm	: Decibel Milliwatt
CIK	: Crypto Ignition Key Identity
CDCSS	: Continuous Digital Coded Squelch System
CTCSS	: Continuous Tone Controlled Squelch System
DCS	: Digital Coded Squelch
DES	: Data Encryption Standard
DSP	: Digital Signal Processing
GPS	: Global Positioning System
ID	: Identity
LCD	: Liquid Crystal Display
MSG	: Message
NAC	: Network Access Code
RF	: Radio Frequency
RSSI	: Received Signal Strength Indicator
RX	: Receive
SC	: Selective Call
TCS	: Tone Coded Squelch
TBX	: Telephone Branch Exchange
TX	: Transmit
WACN	: Wide Area Communication Network

TABLE OF CONTENTS

1	INTRODUCTION.....	1
1.1	Package Contents.....	1
2	INSTALLATION.....	2
3	RADIO CONTROLS AND INDICATORS.....	3
3.1	Front and Rear Views.....	3
3.2	Button and Key Functions.....	4
3.2.1	Emergency Call Button.....	4
3.2.2	Alpha-Numeric keypad.....	4
3.2.3	Up/Down keys.....	4
3.2.4	Left soft key (Menu).....	4
3.2.5	Right soft key (Index).....	4
3.2.6	F1 Button (Power Adjust/Mode Change).....	5
3.2.7	F2 Button (Monitor/Call Wait Option).....	5
3.2.8	Keypad Lock (short press)/Emergency Reset (long press) key.....	5
3.2.9	Scan key.....	5
3.2.10	Star key.....	6
3.2.11	Pound key.....	7
3.3	Programmable Key Function Assignments.....	9
3.4	Alpha-numeric Keypad Entry.....	11
3.5	Display Icons.....	12
4	OPERATION.....	14
4.1	Basic Operation.....	14
4.1.1	Turning the Radio On and Off.....	14
4.1.2	Selecting Zones.....	16
4.1.3	Selecting Channels.....	17
4.1.4	Receiving Signals.....	18
4.1.5	Transmitting to Other Radios.....	20
4.1.6	Selecting Transmit Power.....	24
4.1.7	Selecting Digital Talk Group.....	25
4.1.8	Selecting Talkaround Transmit Mode.....	26
4.1.9	Monitoring Channels.....	27
4.1.10	Selecting Call Wait Option.....	29
4.1.11	Scanning Channels.....	30
4.1.12	Locking the Keypad.....	34
4.1.13	Switching to the Home Zone and Channel.....	35
4.1.14	Initiating Silence Mode.....	35
4.2	Advanced Operation.....	36
4.2.1	Receiving Emergency Calls.....	36
4.2.2	Transmitting Emergency Calls.....	37
4.2.3	Receiving Digital Individual Calls.....	38
4.2.4	Transmitting Digital Individual Calls.....	39
4.2.5	Transmitting Digital All Calls.....	40
4.2.6	Transmitting Digital DTMF/Telephone Dialing.....	41

4.2.7	Receiving a Digital Call Alert.....	42
4.2.8	Transmitting a Digital Call Alert.....	42
4.2.9	Receiving and Sending Non-voice Messages.....	43
4.2.10	Selecting from User Tone List.....	51
4.2.11	Adding and Deleting from Command Zone.....	52
4.2.12	Channel Programming.....	53
4.3	Menu Operation	54
4.3.1	Analog Mode Menu Tree	54
4.3.2	Digital Mode Menu Tree.....	56
5	ACCESSORIES	59
6	STORAGE AND CLEANING PRECAUTIONS	60
7	TROUBLESHOOTING.....	61
8	SPECIFICATIONS	62
8.1	Receiver Technical Specifications.....	64
8.2	Transmitter Technical Specifications.....	65
9	WARRANTY STATEMENT	66

1 INTRODUCTION

1.1 Package Contents

The following items are in your Midland Syn-Tech III P25 Mobile Radio package:

Transceiver Assembly



Microphone



Operation Manual



Microphone Hanger



Power Cord



Loudspeaker



Mounting Bracket

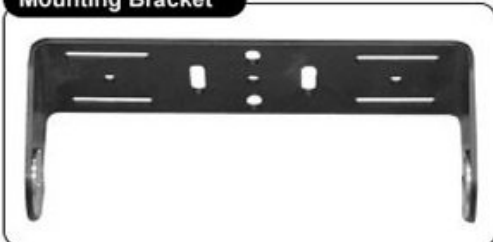



2 INSTALLATION

Installation should be performed by an Authorized Midland LMR Dealer only.

Radio installation should be performed by qualified and trained personnel, familiar with automotive electronics installation, and FCC RF exposure guidelines. This transceiver should be installed in 12V negative ground vehicles only. Installation instructions are available in the corresponding radio service manual.

Antenna selection, installation and positioning requires knowledge of RF radiation and exposure conditions and should be performed by qualified personnel only. Please consult your dealer or communications coordinator for more information.

3 RADIO CONTROLS AND INDICATORS

3.1 Front and Rear Views

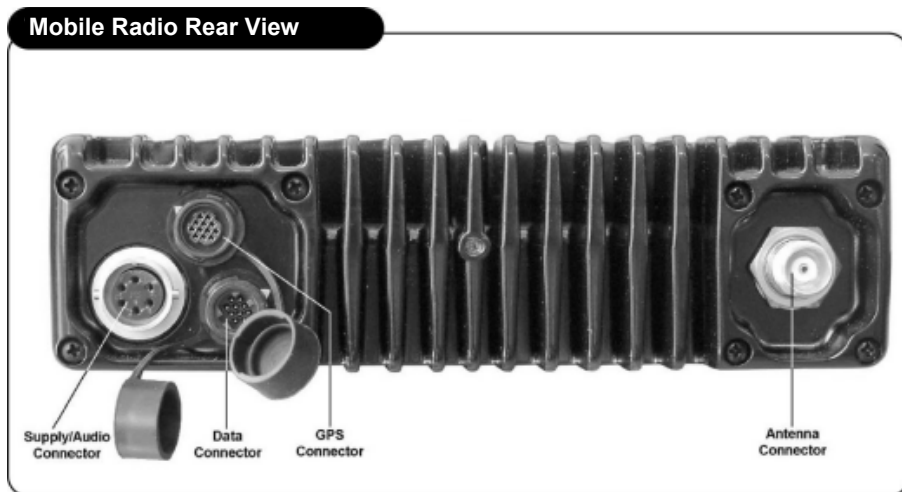
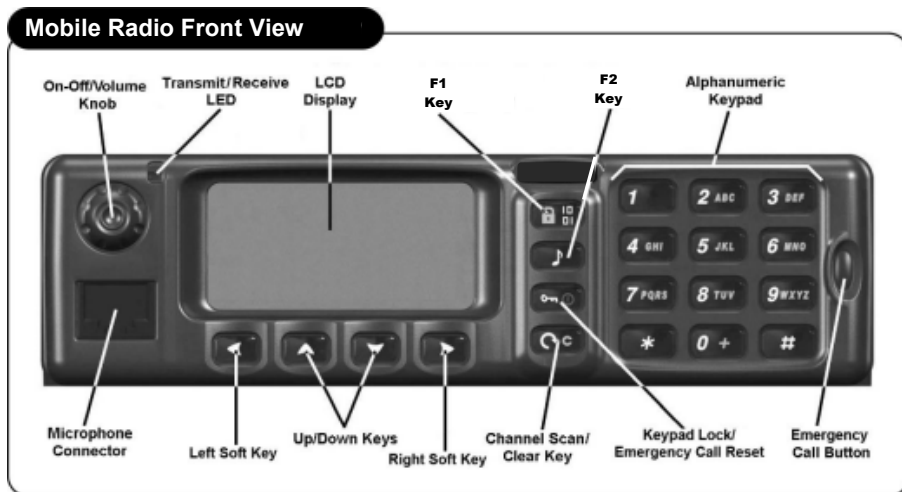

3.2 Button and Key Functions

Below is a brief description of the default operation of each button or key. For more details of each function refer to the operation section of this manual. Many of the functions may be reassigned or disabled by radio programming or unavailable because of the current analog/digital mode selection. Many of the buttons have a short press, or press and release function, and a long press, or press and hold function. The short press function is performed if the button is pressed for less than one second, and the long press function is performed if the button is pressed for more than one second.



3.2.1 Emergency Call Button

The emergency button initiates emergency mode. The emergency key must be pressed for a programmed activation time. Once emergency mode is activated, the radio will switch to the emergency channel and initiate five SBC emergency transmissions. The emergency bit will be set on all user initiated digital transmissions until the emergency is cleared by a long press of the keypad lock key or the radio is turned off.



3.2.2 Alpha-Numeric keypad

The alpha-numeric keypad provides direct channel select from standby mode. The alpha-numeric keypad also generates DTMF tones while PTT is pressed on analog channels and enters alpha-numeric characters within other functions.



3.2.3 Up/Down keys

The up/down keys provide up/down channel select from standby mode. The up/down keys are generally used to scroll through lists within other functions.



3.2.4 Left soft key (Menu)

The left soft key enters the menus from standby mode. The left soft key is generally used as SELECT or OK within other functions.



3.2.5 Right soft key (Index)

The right soft key accesses the index (20 unit ID address book) from standby mode.

Once the appropriate ID is displayed, press SELECT to edit the entry or the  (scan) to initiate an individual call to the displayed unit. Up to six of the first entries may

be predefined in radio programming and may not be editable. Individual call initiation may be disabled by radio programming.

The right soft key is generally used as EXIT within other functions. The right soft key is used a nuisance channel delete during scan.



3.2.6 **F1 Button (Power Adjust/Mode Change)**

A long press of this key changes the transmit power level. The selections are high, medium and low power. A default power level is set each time the channel is selected.

A short press of this key changes the transmit mode on multi-mode and digital channels. The selections may include analog, digital clear, and digital encrypted transmit modes. A default mode is set each time the channel is selected.



3.2.7 **F2 Button (Monitor/Call Wait Option)**

A long press of this key turns monitor on. The function of the monitor button depends on digital/analog/mixed mode and the radio programming. If monitor is enabled the monitor function may disable the squelch on analog and mixed channels. The monitor function may allow all NACs and talk groups to be received on digital and mixed channels. While monitor is on, a long press of the Monitor/Call Wait key turns monitor off.

A short press of this key turns the call wait option on. The call wait option is available only on digital channels. When the call wait option is on, group calls will be muted. If an individual call (addressed to the radio) or all call is received, the call will be heard and the call wait option will be canceled. While call wait is on, a short press of the Monitor/Call Wait key turns call wait off.



3.2.8 **Keypad Lock (short press)/Emergency Reset (long press) key**

A short press of this key initiates keypad lock. While the keypad is locked, a short press of the Keypad Lock/Emergency Reset key will initiate keypad unlock mode.

While the emergency function is active, a long press of the Keypad Lock/Emergency Reset key will cancel the emergency mode.



3.2.9 **Scan key**

A short press of this key turns on scan. All channels in the selected zone's scan list will be scanned. If PTT is pressed while scanning, the radio will transmit on the selected channel. If PTT is pressed while scan is paused on a channel the radio will transmit on

the pause channel. If MENU is pressed scan is canceled. While scan is on, a short press of the Scan key cancels scan.

The Scan key is also used as a clear (long press) or backspace (short press) key during alpha-numeric keypad entry.

3.2.10 Star key

The * key is a multi-function key allowing selection of several functions with successive presses. The available functions depend on analog/digital mode. In digital mode the talk group select, all call, talkaround, home and command zone functions may be available. In analog mode the talkaround, home and command zone functions may be available.

3.2.10.1 Switching Talk Group

The first press of the * key may prompt “TALKGROUP.” to enter a new talk group. This function is only available in digital mode and the entered talk group must be in the selected zone’s talk group list.

3.2.10.2 Entering/Exiting Unaddressed Voice Call Mode

Successive presses of the * key may prompt “ENTER TO ALL CODE MODE?” or “EXIT ALL CODE MODE?” to enter/exit all call mode. This function is only available in digital mode. All call mode implements a call to all talk groups using the channel.



Transmitting all calls may be disabled by radio programming.

3.2.10.3 Entering/Exiting Talkaround Mode

Successive presses of the * key may prompt “ENTER TO TALKAROUND MODE?” or “EXIT TALKAROUND MODE?” to enter/exit talkaround mode. This option is not available on simplex (direct) channels. The talkaround function sets the transmitter to the programmed receive frequency/CTCSS/DCS/NAC.

3.2.10.4 Switching to Home Zone and Channel

Successive presses of the * key may prompt “GO TO HOME?” to switch to the home zone and channel.

3.2.10.5 Adding to Command Zone

Successive presses of the * key may prompt “ADD TO COMMAND ZONE?” to add the current channel to the command zone.

3.2.11 Pound key

The # key is a multi-function key allowing selection of several functions with successive presses. The available functions depend on analog/digital mode. In digital mode the zone select, status set, individual call, telephone call and call alert functions may be available. In analog mode the zone select, selective call and two tone call functions may be available.

3.2.11.1 Switching Zones

The first press of the # key may prompt “ZONE NO:” to switch zones. The up/down keys will scroll through the available zones. Or, the zone number may be entered using the numeric keypad. The left soft key selects the displayed zone and the right soft key exits without changing zones.

3.2.11.2 Setting Current Status

Successive presses of the # key may prompt “CUR. STATUS:” to set the current status. This function is only available in digital mode. The current status is used when sending status to other users, or when other users request the current status. The current status may also be set under MENU | STATUS | PRESENT STATUS.



Sending current status and requesting status from other users may be disabled in radio programming. You may still set current status and receive status messages from other users.

3.2.11.3 Entering Individual Call Mode

Successive presses of the # key may prompt “INDIVIDUAL:” to enter individual call mode. This function is only available in digital mode. A unit ID may be entered or selected from the index list. Once a unit ID is selected, the radio will enter individual call mode. The radio will transmit unit to unit calls to the entered unit ID each time PTT is pressed. If PTT is not pressed and no signal is received the individual call mode will time out after ten seconds.



Individual calling may be disabled by radio programming.

3.2.11.4 Initiating a Telephone Interconnect Request

Successive presses of the # key may prompt “DIAL TELEPHONE NUMBER” to initiate a telephone call. This function is only available in digital mode. This function initiates a telephone interconnect request on the RF subsystem.



Telephone dialing may be disabled or the number of dial digits may be limited by radio programming.

3.2.11.5 Sending a Call Alert

Successive presses of the # key may prompt “CALL ALERT:” to initiate a call alert transmission. This function is only available in digital mode.



Call alert transmissions may be disabled by radio programming.

3.2.11.6 Transmitting a Selective Call

Successive presses of the # key may prompt “SELECTIVE CALL” to transmit a selective call. This function is only available in analog mode.



Selective calling may be disabled by radio programming.

3.2.11.7 Transmitting a 2-Tone Call

Successive presses of the # key may prompt “TWO-TONE CALL” to transmit a 2-tone call. This function is only available in analog mode.



Two-tone calling may be disabled by radio programming.

3.3 Programmable Key Function Assignments

The preceding section detailed the default functions for each key. However, many of the keys may be programmed to perform other functions. You may find it convenient to record the new functions of the programmable keys below. Please keep in mind, some functions may not be available because of the analog/digital mode selection.



alpha-numeric keypad:

1 key long press: _____

2 key long press: _____

3 key long press: _____

4 key long press: _____

5 key long press: _____

6 key long press: _____

7 key long press: _____

8 key long press: _____

9 key long press: _____

0 key long press: _____



* key list:

1. _____

2. _____

3. _____

4. _____

5. _____

6. _____



* key long press: _____



key list:

1. _____

2. _____

3. _____

4. _____

5. _____

6. _____



key long press: _____



up/down keys: _____



right soft key: _____



F1 key short press: _____



F1 key long press: _____



F2 key short press: _____



F2 key long press: _____



scan key: _____

3.4 Alpha-numeric Keypad Entry

The keypad is used to enter alpha-numeric characters within many functions. When the radio is in alpha-numeric mode, successive presses (less than one second apart) of the keys will step through the available characters. Pausing for more than a second will accept the displayed character and move the cursor right one space. A short press of

the  (Scan/Clear) key deletes the previous character and moves the cursor left



one space. A long press of the  (Scan/Clear) key returns the radio to standby mode.

Table 3.1: Alpha-numeric Keypad Entry

Keys	Number of Key Presses										
	1	2	3	4	5	6	7	8	9	10	11
1	Space	1									
2	A	B	C	2	a	b	c	Ç	ç		
3	D	E	F	3	d	e	f				
4	G	H	I	4	g	h	i	Ğ	ğ	İ	ı
5	J	K	L	5	j	k	l				
6	M	N	O	6	m	n	o	Ö	ö		
7	P	Q	R	S	7	p	q	r	s	Ş	ş
8	T	U	V	8	t	u	v	Ü	ü		
9	W	X	Y	Z	9	w	x	y	z		
0	0	+	.	,	:	;	!	"	'		
	*	/	\	-	()	@				
	#	?	€	\$	%	&	<	=	>		

3.5 Display Icons

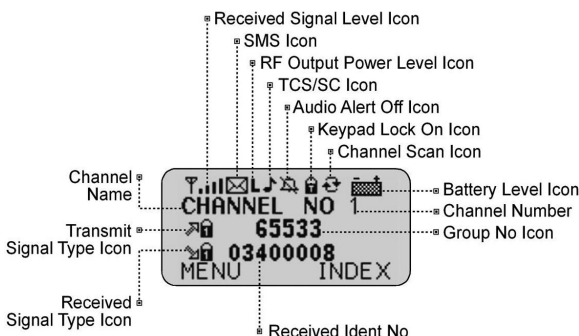















Table 3.2: Display Icons

	This Analog Receive icon appears when an analog signal is received.
	This Analog CTCSS Receive icon appears when an analog signal encoded with the correct CTCSS is received.
	This Analog CDCSS Receive icon appears when an analog signal encoded with the correct CDCSS is received.
	This Digital Receive icon appears when a clear (unencrypted) digital signal is received.
	This Digital DES Receive icon appears when an encrypted digital signal using the DES encryption algorithm is received.
	This Digital AES Receive icon appears when an encrypted digital signal using the AES encryption algorithm is received.
	This Analog Transmit icon appears when the radio is set to transmit in analog mode.
	This Analog CTCSS Transmit icon appears when the radio is set to transmit in analog mode with CTCSS.
	This Analog CDCSS Transmit icon appears when the radio is set to transmit in analog mode with CDCSS.
	This Analog Mixed Reply Transmit icon appears after the radio receives an analog transmission on a mixed mode channel (temporary switch to analog TX).
	This Digital Transmit icon appears when the radio is set to transmit in clear digital mode.
	This Digital Mixed Reply Transmit icon appears after the radio receives a digital transmission on a mixed mode channel (temporary switch to digital TX).
	This Digital DES Transmit icon appears when the radio is set to transmit in digital encrypted mode using the DES encryption algorithm.
	This Digital AES Transmit icon appears when the radio is set to transmit in digital encrypted mode using the AES encryption algorithm.

	This Digital Talkaround Receive icon appears when a clear digital signal is received in direct or talkaround mode.
	This Analog Talkaround Transmit icon appears when the radio is set to transmit in analog talkaround mode.
	This Digital Talkaround Transmit icon appears when the radio is set to transmit in digital talkaround mode.
	This Received Signal Level icon appears when a signal is being received. The number of bars indicates the relative signal strength.
	This SMS icon appears after an SMS is received and remains on until the message is read.
	This High Power icon appears when high transmit power level is selected.
	This Medium Power icon appears when medium transmit power level is selected.
	This Low Power icon appears when low transmit power level is selected.
	This Tone Squelch icon appears when channel is set to receive a CTCSS or CDCSS signal.
	This Call Wait icon appears when call wait mode is selected.
	This Alert Tones Off icon appears when alert tones are disabled or silence mode is on.
	This Keypad Lock icon appears when keypad lock is selected.
	This Scan icon appears when scan is selected.
	This Low Battery icon appears when a low voltage condition is detected.

4 OPERATION

4.1 Basic Operation

Despite the radio's advanced feature set, the basic receive and transmit operations can still be quite simple. The radio is capable of distinguishing between analog and digital signals, and the channel may be configured to receive both signal types with no user intervention. The radio channel may also be configured to allow users to transmit analog signals, digital signals, or choose the appropriate transmit mode. The radio may also automatically switch the transmit mode after receiving a different mode signal. The radio will switch back to the selected mode after a time period.

4.1.1 Turning the Radio On and Off



Figure 4.1 – On/Off

Press and release the On/Off Volume Knob to turn the mobile radio on. Press and hold the On/Off Volume Knob at least two seconds to turn the mobile radio off. Rotate the knob clockwise to increase the speaker volume. Rotate the knob counter-clockwise to decrease the speaker volume.



Figure 4.2 – Increase volume

While the radio is performing power-on self-tests, it will display the greeting message and the current zone selection. The radio will power-on to the last selected channel.



Figure 4.3 – Decrease volume

If a power-on password has been set, the radio will prompt for power-on password entry when it is turned on. Use the numeric keypad to enter the correct 6-8 digit password, then press the left soft key (OK).

Enter 6-8
digit
password

Press OK
to
continue

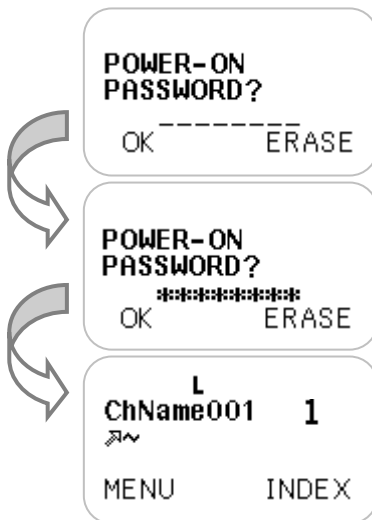

Figure 4.4 – Power-on password entry

If a user password has been set, the radio will prompt for user password entry when it is turned on. Use the numeric keypad to enter the correct 5 digit user password, then press the left soft key (OK).

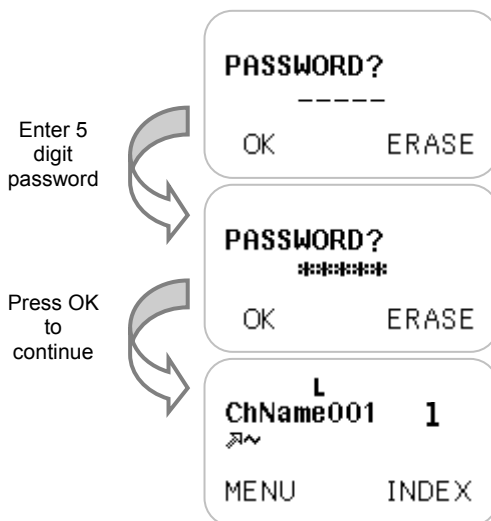

Figure 4.4 – User password entry



The power-on and user passwords have similar functions. The power-on password is enabled and changed by the radio programmer. The user password is enabled and changed by the radio user.

4.1.2 Selecting Zones

The radio channels may be organized into zones or channel groupings to sort and organize the channels. To select a new zone, press the zone



entry key (default: pound key), then use the up/down keys to scroll through the available zones. The new zone number may also be entered using the keypad. Press the left soft key (OK) to switch to the new zone. The first channel in the new zone will be displayed.

Not sure which zone is currently selected? Press the zone entry key to display the current zone selection. Press exit to return to standby mode.

A new zone may also be selected using zone up/zone down keys.

A new zone may also be selected using MENU | CHANNEL PARAMETERS | ZONES.

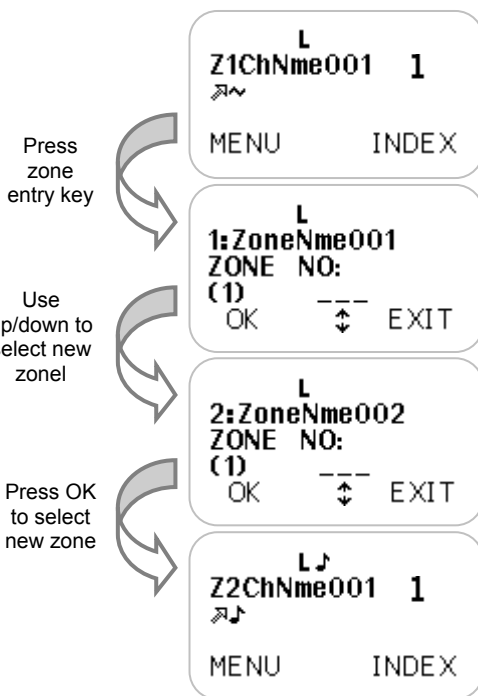



Figure 4.5 – Zone selection

4.1.3 Selecting Channels

The  (up/down) keys may be used to increment or decrement the channel selection.



The  (alpha-numeric keypad) may be used to enter a channel number for direct channel selection.

Enter channel number

Press OK

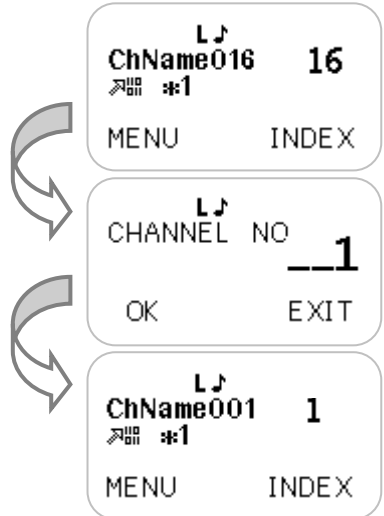

Figure 4.7 – Direct channel number entry

4.1.4 Receiving Signals

The radio channel may be configured to receive only analog transmissions, only digital transmissions or both. If the channel is programmed to receive both analog and digital signals (mixed mode receive), the radio will automatically switch to the appropriate mode when receiving the signal.

4.1.4.1 Analog Reception







An analog signal exceeding the squelch threshold is indicated by a green Transmit/Receive LED and the Analog Receive icon (). On channels programmed for tone squelch, the decoded tone squelch signal is indicated by the CTCSS Receive icon () or CDCSS Receive icon (). A relative value of signal strength is also indicated by the Received Signal Level icon (). If the channel's analog reception parameters are met, the received audio is heard over the speaker.





Figure 4.8 – Analog receive display



4.1.4.2 Digital Reception

A decoded digital signal is indicated by a green Transmit/Receive LED and the Digital Receive icon (). A relative value of signal strength is also indicated by the Receive Signal Strength icon (). If the channel's digital reception parameters are met, the received audio is heard over the speaker.

4.1.4.3 Encrypted Digital Reception

A decoded encrypted digital signal is indicated by a green Transmit/Receive LED and the Digital DES Receive icon () or Digital AES

Receive icon (). A relative value of signal strength is also indicated by the Receive Signal Strength icon (). If the channel's digital reception parameters are met and the encryption keys are matched, the received audio is heard over the speaker.

More information is displayed about received digital signals. While receiving, the talk group ID is displayed in decimal format on the third line (***1**), and the source ID is displayed in decimal format on the fourth line (**00000001**). If the received source ID is in the radio's address book, the name associated with the source ID will be displayed (**IndxNm01**). If the received signal has status bits set to 0, the direct or Digital Talkaround icon is displayed to the left of the source ID (), otherwise the Digital Receive icon is displayed (). To the right of the talk group ID is a single letter indicating the emergency bit is normal (**N**) or emergency (**E**). To the right of the source ID is a single letter indicating the link control format is a group call (**G**) or individual call (**I**).

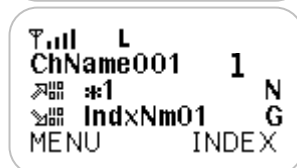
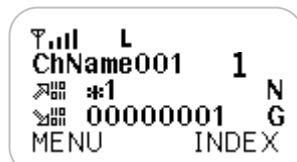

Figure 4.9 – Digital receive display

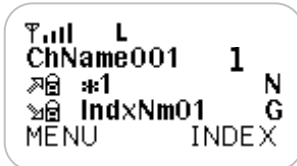
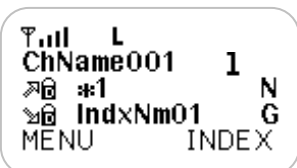

Figure 4.10 – Encrypted receive display

4.1.5 Transmitting to Other Radios

The radio channel may be configured to transmit in analog mode, digital mode or encrypted mode.

Your radio may allow you to select the transmit mode with the TX Mode



Change key (default: short press F1 key). A default transmit mode is chosen by radio programming. The default transmit mode is used each time the channel is selected or radio is turned on. The other available modes may be chosen by successive presses of the TX Mode Change key.

Your radio may automatically switch the transmit mode to the last received mode. This mixed reply transmit mode will display the Analog Mixed Reply Transmit icon (🎵🔒) or Digital Mixed Reply Transmit icon (🔒📡). When a reply timer expires the radio will switch back to the previously selected mode.

Press Mode Change key to select next TX mode

Press Mode Change key to select next TX Mode



Figure 4.11 – Transmit mode selection



Figure 4.12 – Mixed reply display

4.1.5.1 Analog Transmissions

1. Press the TX Mode Change key repeatedly until analog transmit mode is displayed. Depending on channel programming, the analog transmit mode may display the Analog Transmit icon (📡), Analog CTCSS Transmit icon (📡🎵) or Analog CDCSS Transmit icon (📡🎵🔑).
2. Ensure that the channel is clear.
3. Press and hold the push to talk key (PTT). The Transmit/Receive LED will light red while transmitting.
4. Hold the microphone approximately two inches from your mouth and speak in a clear, normal voice. Keep the PTT switch pressed until you have finished speaking.
5. Release the PTT switch to return to standby mode and receive any reply.



Figure 4.13 – Analog transmit displays

4.1.5.2 Digital Transmissions

1. Press the TX Mode Change key repeatedly until the Digital Transmit icon () is displayed.
2. Check that the correct talk group ID is selected.
3. Ensure that the channel is clear.
4. Press and hold the push to talk key (PTT). The Transmit/Receive LED will light red while transmitting.
5. Hold the microphone approximately two inches from your mouth and speak in a clear, normal voice. Keep the PTT switch pressed until you have finished speaking.
6. Release the PTT switch to return to standby mode and receive any reply.

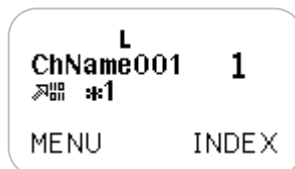

Figure 4.14 – Digital transmit display

4.1.5.3 Encrypted Transmissions



1. Press the TX Mode Change key repeatedly until encrypted transmit mode is displayed. Depending on channel programming, the encrypted transmit mode may display the Digital DES Transmit icon () or Digital AES Transmit icon ().
2. Check that the correct talk group ID is selected.
3. Ensure that the channel is clear.
4. Press and hold the push to talk key (PTT). The Transmit/Receive LED will light red while transmitting.
5. Hold the microphone approximately two inches from your mouth and speak in a clear, normal voice. Keep the PTT switch pressed until you have finished speaking.
7. Release the PTT switch to return to standby mode and receive any reply.



Figure 4.15 – Encrypted transmit display

4.1.5.4 Time Out Time

A Time Out Time may be programmed to limit the length of continuous transmissions. If the Time Out Time is exceeded, release PTT and wait for the channel to be available again. The Time Out Time may be set from 15-240 seconds in radio programming.



Figure 4.16 – Transmit time out

4.1.5.5 Busy Channel Lockout

The radio may be programmed to inhibit transmission while the channel is busy. Wait until the channel is clear before transmitting.



Figure 4.17 – Busy channel lockout

4.1.6 Selecting Transmit Power

To minimize interference with others, use the lowest transmit power that will provide adequate range. The radio has three transmit power levels which are selected with successive long presses of the Power Change



key (Default: long press F1 key). The actual transmit power associated with each level is set in radio programming.

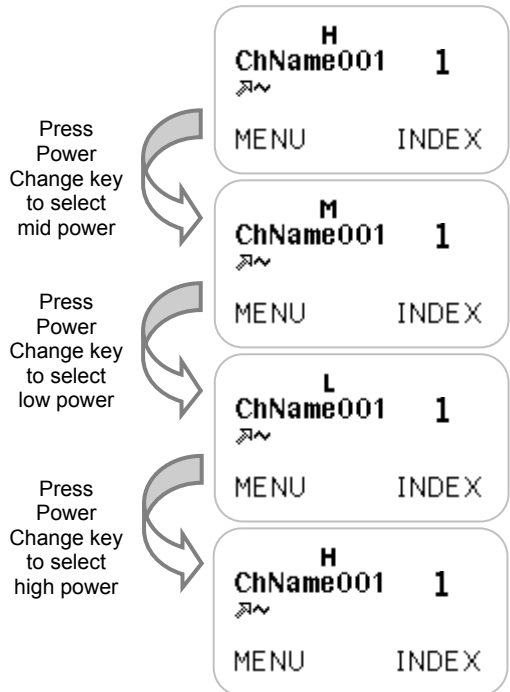

Figure 4.18 – Transmit power selection

4.1.7 Selecting Digital Talk Group

The default talk group may be set for the channel in radio programming. When the channel is selected, the default talk group is used. If a default talk group was not set for the channel, the radio will use the talk group last selected and displayed.

Each zone in the radio may have a list of allowed talk groups or may have all valid talk groups assigned to it. When the radio is in digital transmit mode, you may select a new talk group from this list by pressing the Talk Group Entry key



(default: * star key) until "TALKGROUP:" is displayed.

Then use the alpha-numeric keypad to enter the new talk

group. Then press the left soft key (OK) to use the entered talk group. If the entered talk group is not in the zone's talk group list, the radio will not allow the talk group selection.

If a talk group list has been created for the zone, a new talk group may also be selected using the Group Up/Group Down keys. The zone's talk group list may be viewed and a new talk group may also be selected from MENU | CHANNEL PARAMETERS | TALKGROUPS.

The radio has a talk group scan feature which is on by default. When a signal is received from any talkgroup in the list, the radio will switch to the received talkgroup for the duration of the receive signal and then start the scan delay timer. You may reply using the received talk group during the scan delay time, by pressing PTT. After the scan delay time expires the radio will switch back to the selected talk group. Use MENU | CHANNEL PARAMETERS | TALKGROUP SCAN to turn talk group scan on/off.

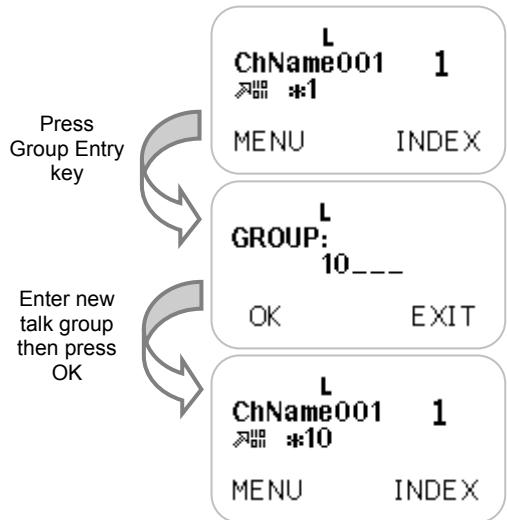



Figure 4.19 – Group Entry talk group selection

4.1.8 Selecting Talkaround Transmit Mode

On channels programmed for repeater operation, the radio may be set to talkaround mode. Talkaround mode allows direct portable to portable communication without accessing the repeater. Press the Talkaround Mode key (default:



star key) until “ENTER TO TALKAROUND MODE?” is displayed then press the left soft key (YES). The radio will switch it’s transmit frequency parameters to those programmed for receive. The Analog Talkaround Transmit icon () or Digital Talkaround Transmit icon () is displayed while talkaround mode is active

The radio will remain in talkaround mode until it is canceled, the channel is changed, the radio is turned off, or a new zone is selected. To cancel talkaround mode, press the Talkaround Mode key until “EXIT TALKAROUND MODE?” is displayed, then press the left soft key (YES).

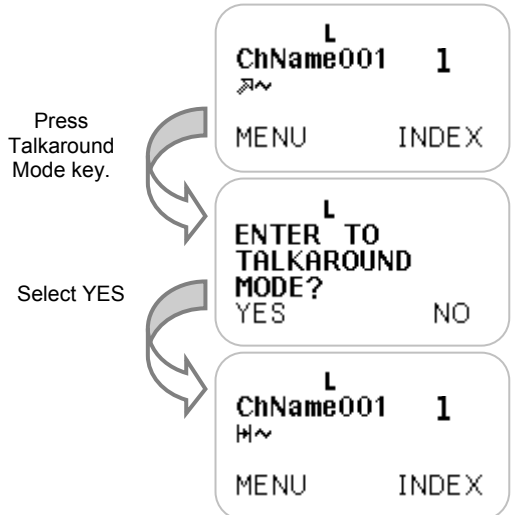

Figure 4.20 – Entering talkaround mode

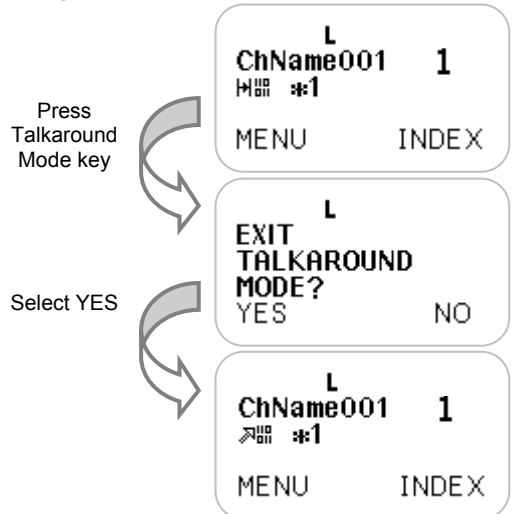



Figure 4.21 – Exiting talkaround mode

4.1.9 Monitoring Channels

Press the Monitor Change key

(default:  long press F2 button) to turn the monitor function on. The function of the monitor button depends on radio programming. If Monitor Channel is enabled, the monitor function will disable the squelch on analog and mixed channels.

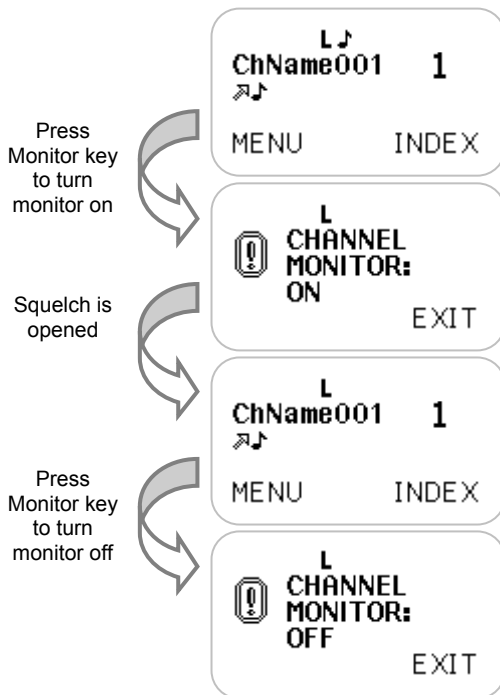

Figure 4.22 – Monitoring channel

If Monitor All NACs & T.Groups is enabled, the monitor function allows all NACs and talk groups to be received on digital and mixed channels. While monitor is on, a press the Monitor Change key to turn monitor back off.

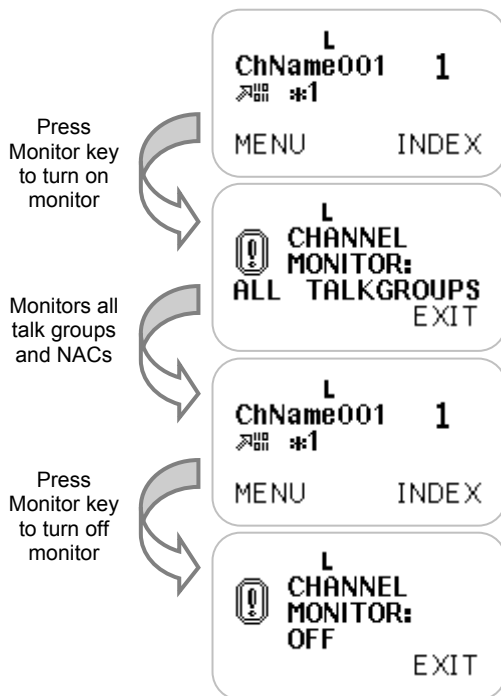



Figure 4.23 – Monitoring all talk groups and NACs

4.1.10 Selecting Call Wait Option

Press the Individual Call Wait key

(default:  short press F2 button) to turn the call wait option on.

The Call Wait icon () is displayed while call wait mode is on. While the call wait option is on, all normal group calls will be muted while the radio waits for an individual. On digital channels, if an individual call (with matching destination ID) or all call is received, the call will be heard and the call wait option will be canceled. On analog channels, if a matching 2-tone or 5-tone call is received the call will be heard and the call wait option will be canceled. While call wait is on, press of the Individual Call Wait key to turn call wait off.

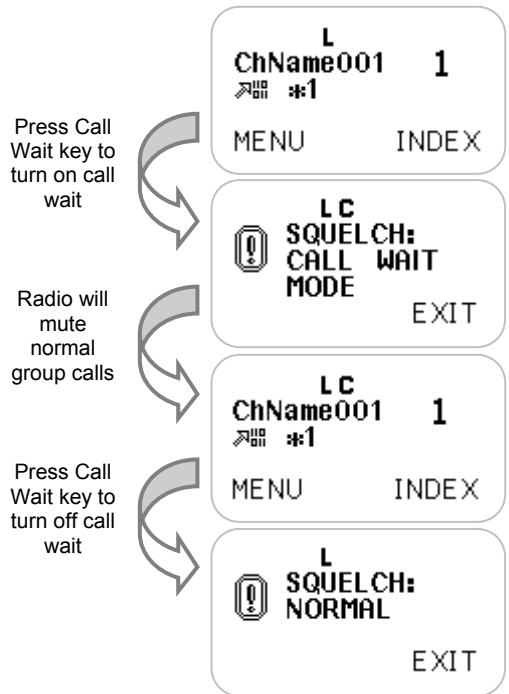



Figure 4.24 – Selecting call wait option

4.1.11 Scanning Channels

Press the Busy Scan, Priority Scan or Selected Priority Scan key (default:  short press scan key) to turn on scan. The Scan icon () is displayed while scan is active. All channels in the selected zone's scan list will be scanned. While scan is on, press the scan key to cancel scan. If MENU is pressed, scan is canceled.

4.1.11.1 Busy Scan

Busy scan will scan all channels in the selected zone's scan list. Any priority channel assignments will be ignored.

4.1.11.2 Priority Scan

Priority scan will scan all channels in the selected zone's scan list. The assigned high and low priority channels will be used. While scan is paused on a non-priority channel, the priority channels will be checked for activity.

4.1.11.3 Selected Priority Scan

Selected priority scan will scan all channels in the selected zone's scan list. The selected channel will be assigned and used as the high priority channel. If a low priority channel has been assigned it will also be used. While scan is paused on a non-priority channel, the priority channels will be checked for activity.

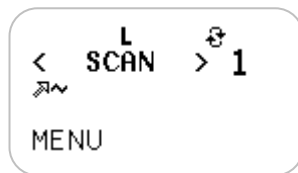

Figure 4.25 – Busy scan display

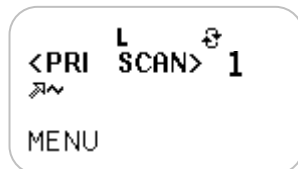

Figure 4.25 – Priority scan display

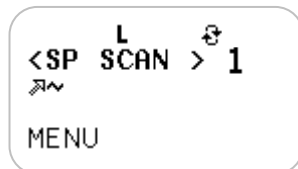

Figure 4.25 – Selected priority scan display

4.1.11.4 Transmitting While Scanning

If PTT is pressed while scanning the radio will transmit on the selected channel.

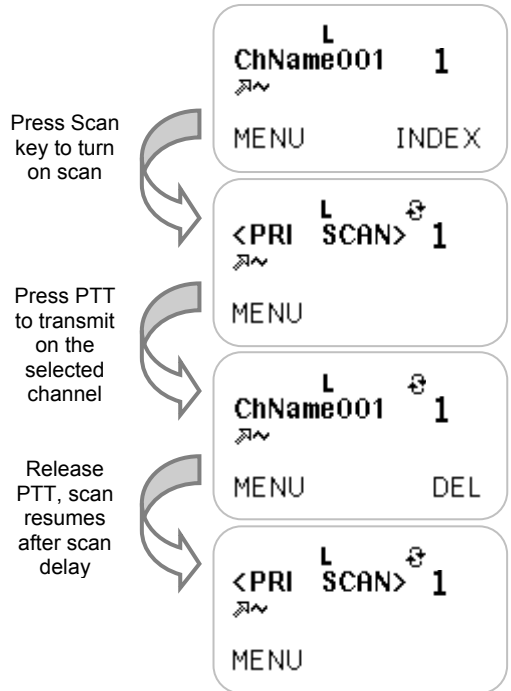

Figure 4.26 – Pressing PTT while scanning

If PTT is pressed while scan is paused on a channel the radio will transmit on the pause channel.

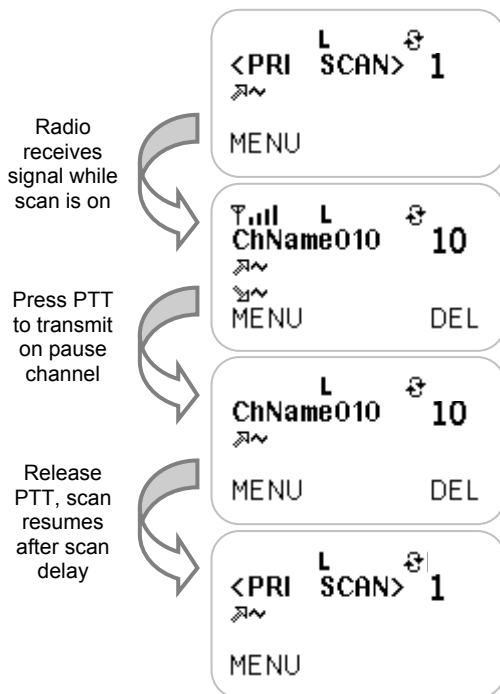

Figure 4.27 – Pressing PTT while scan is paused

4.1.11.5 Editing the Scan List

You can add and delete channels from the selected zone's scan list using MENU | CHANNEL PARAMETERS | CHANNEL SCAN. If a "+" is displayed above the channel name, the channel is currently in the scan list. If "-" is displayed above the channel name, the channel is not in the scan list. A "1" or "2" indicate priority channel selections.

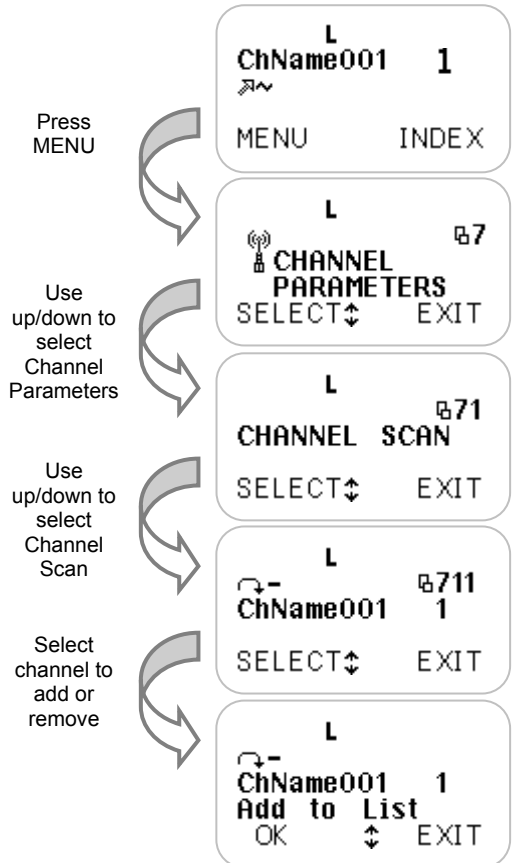



Figure 4.28 – Editing the zone's scan list

4.1.12 Locking the Keypad

Press the  (Keypad Lock) key to lock the alpha-numeric, up/down, scan, and left and right soft keys. While the keypad is

locked, press the  (Keypad Lock) key, then press the left soft key (UNLOCK) to unlock the keypad.

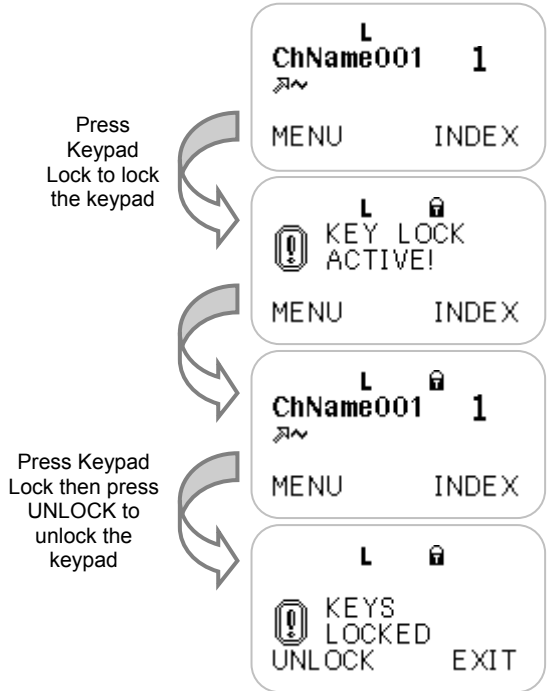



Figure 4.29 – Locking the keypad



Keypad lock may be disabled in radio programming. The F1 and F2 side buttons may be programmed to lock with the keypad.

4.1.13 Switching to the Home Zone and Channel

Press the Home Zone key

(default:  star key) until "Go to Home?" is displayed. Then press the left soft key (OK) to switch to the home zone and channel. If the channel switch is not in the sixteenth position, the radio will switch to the home zone and the channel selected by the switch. The home zone and channel are set in radio programming.

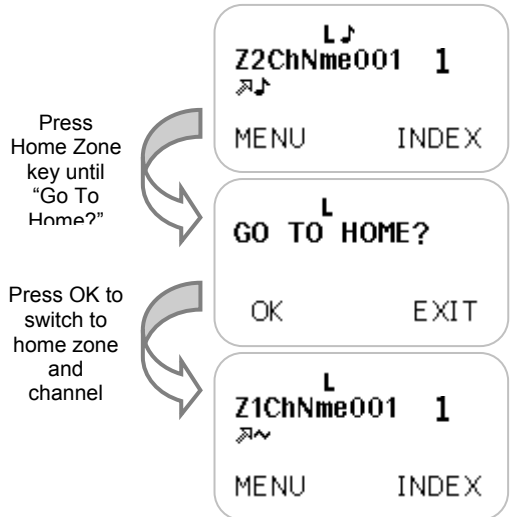

Figure 4.30 – Switching to home zone & channel

4.1.14 Initiating Silence Mode

Press the Silence Mode key to turn on Silence Mode. Silence mode turns off the transmit/busy LED, display backlighting and radio beeps. Press the Silence Mode key again to turn silence mode off.

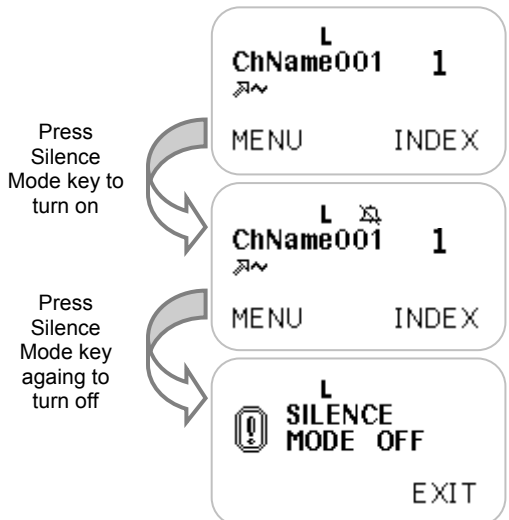

Figure 4.31 – Turning Silence Mode on/off

4.2 Advanced Operation

Some of the radio's more advanced operations are listed in this section. Most of these advanced features may be disabled in radio programming. In this case, the feature being described may not appear, or may have a reduced, view only function.

4.2.1 Receiving Emergency Calls

When an emergency alert transmission is received, the radio sounds and displays the emergency alert and displays the unit ID of the sender. Pressing any key will silence the alert tone. Press the right soft key to exit the emergency display mode. When a call with the emergency bit set is received the radio displays the call with emergency bit indicator (**E**).

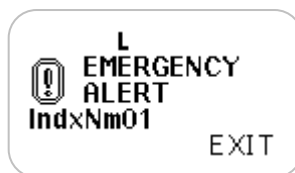

Figure 4.32 – Emergency alert display

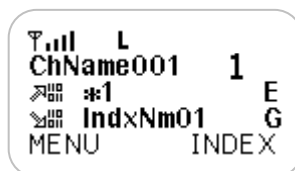

Figure 4.33 – Emergency call display

4.2.2 Transmitting Emergency Calls



Press and hold the (emergency) key to activate the emergency function. Once emergency mode is activated, the radio switches to the emergency channel set for the selected zone in radio programming or initiates the emergency transmissions on the current channel.

The radio will automatically transmit five emergency alert transmissions and set the emergency bit on all user initiated transmissions until the emergency is cleared. The emergency is cleared by a long



press of the (Keypad Lock) key or by turning the radio off.

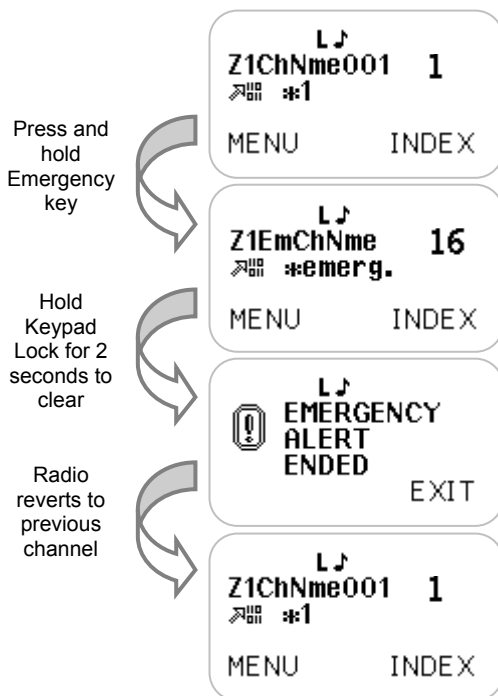

Figure 4.34 – Transmitting in emergency mode



Emergency calls may be disabled in radio programming. When emergency calls are disabled the emergency button will not function.

4.2.3 Receiving Digital Individual Calls

A digital individual call is addressed to a single unit ID rather than a talk group. When this radio receives an individual call from another radio it will automatically switch to individual call mode. The radio will use the received source ID as the destination ID in individual call replies.

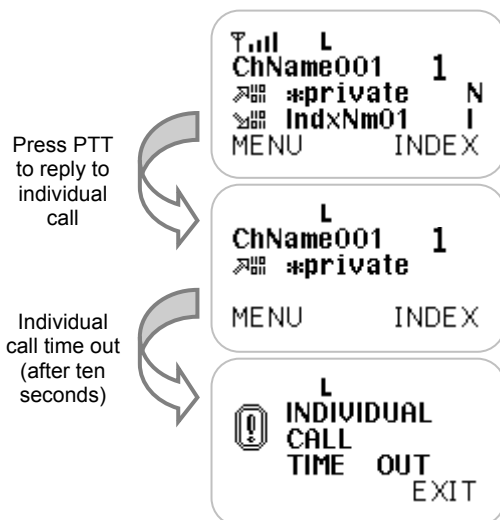

Figure 4.35 – Receiving individual call



If no signal is received and PTT is not pressed for ten seconds, individual call mode will time out.

4.2.4 Transmitting Digital Individual Calls

A digital individual call is addressed to a single unit ID rather than a talk group. To transmit an individual call, press the Individual Entry key



(default: pound key) until "INDIVIDUAL:" is displayed. Enter the unit ID or press the left soft key (INDEX) to select from the address book. Press the left soft key (OK) to enter individual call mode.

Then press PTT to initiate an individual call to the selected unit ID.

An individual call may also be initiated directly from the index by selecting the index entry, then pressing the



(scan key).

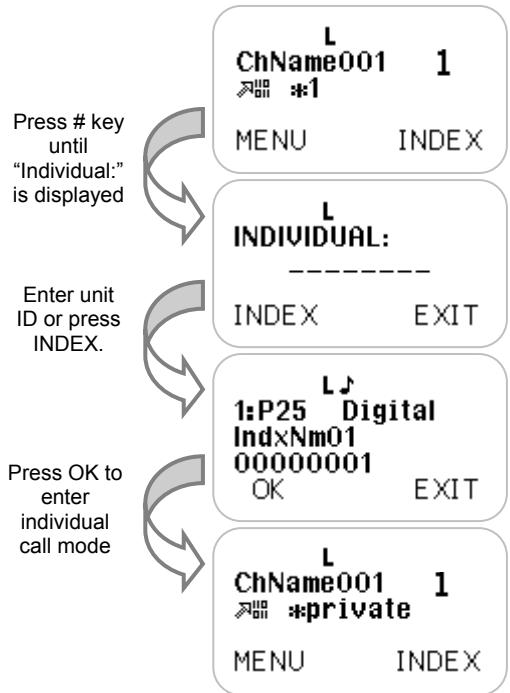

Figure 4.36 – Entering individual call mode



If no signal is received and PTT is not pressed for ten seconds, individual call mode will time out.



Individual call initiation may be disabled in radio programming.

4.2.5 Transmitting Digital All Calls

A digital all call is similar to a group call, except no talk group is specified (reserved talk group \$FFFF is used). Any digital radio with matching receive frequency and NAC should receive the all call.

To enter all call mode, press the



All Call key (default: * star key) until “ENTER TO ALL CODE MODE?” is displayed, then press the left soft key (YES). The radio will now transmit with reserved talk group \$FFFF.

To exit all call mode, press the All Call key until “EXIT ALL CODE MODE?” is displayed then press the left soft key (YES).

Press All Call key until “Enter to Unaddressed Voice Call?”

Press YES



Figure 4.37 – Entering all call mode



All call initiation may be disabled in radio programming.

Press All Call key until “Exit Unaddressed Voice Call?”

Press YES



Figure 4.38 – Exiting all call mode

4.2.6 Transmitting Digital DTMF/Telephone Dialing

Press the Telephone Entry key

(default:  pound key) until "DIAL TELEPHONE NUMBER" is displayed. Press the left soft key (OK) then enter the telephone dialing digits. Press the left soft key (CALL). The radio will send a telephone dialing request.

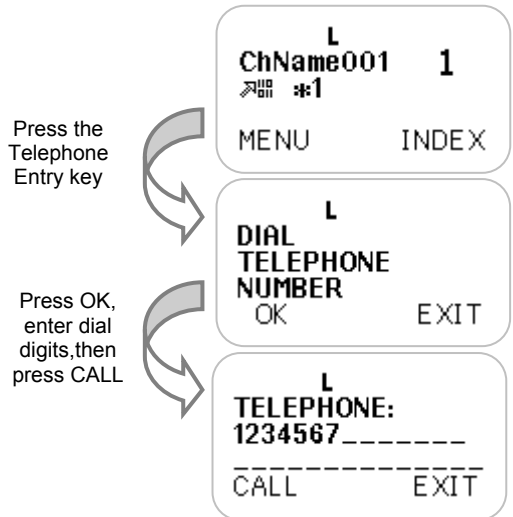

Figure 4.39 – Initiating DTMF/telephone dialing



Telephone interconnect calls may be disabled or the number of dial digits may be limited in radio programming.

4.2.7 Receiving a Digital Call Alert

A call alert is normally used as a low priority request to return the call when it's more convenient. When a call alert is received the radio will display the unit ID of the initiator.

4.2.8 Transmitting a Digital Call Alert

Press the Call Alert key (default:



pound key) until "CALL ALERT:" is displayed. Enter the destination unit ID or press the left soft key for INDEX. Press the left soft key (SEND) to send the call alert. The radio will send up to four call alert requests.



Call alert transmissions may be disabled in radio programming.



Figure 4.40 – Receiving a call alert

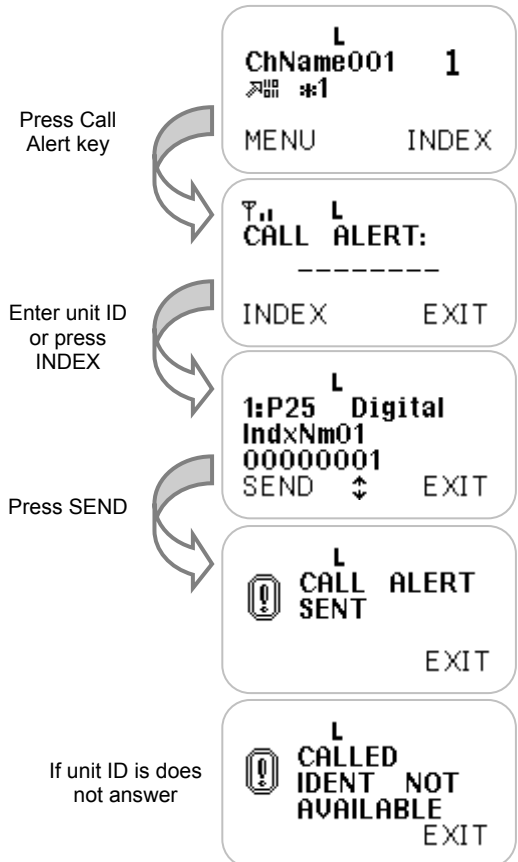

Figure 4.41 – Initiating a call alert request

4.2.9 Receiving and Sending Non-voice Messages

The radio can receive and send three types of non-voice messages when operating in digital mode.

SMS messages are free text messages sent from one radio to another. With SMS messages, the message (up to 160 characters maximum) is entered using the alphanumeric keypad and transmitted to the other radio.

Predefined messages are common messages among all radios. A predefined message is selected from the predefined message list (of 20 messages of maximum 20 characters) and the message pointer is transmitted to the other radio.

Status messages are common status settings among all radios. A current status is selected by the radio user (of 30 status settings of maximum 20 characters), and may be sent to another radio. Your current status may also be queried by another user.



Both status and predefined messages rely on the receiving radio's database to determine the message displayed. The message characters are not sent, instead only a pointer of which message should be displayed is sent. For proper status and predefined messaging operation, both the receiving and transmitting radios should be using the same message database.

4.2.9.1 Receiving SMS Messages

When an SMS message is received, the radio will display the SMS Message icon (). You may view the last twenty received SMS messages from MENU | SMS | RECEIVED MESSAGES.

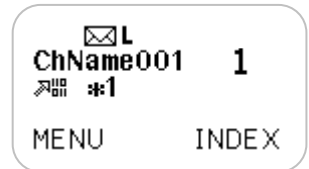



Figure 4.42 – SMS message received



The  icon indicates unread messages and will remain on until all new messages have been viewed. Within the Received Messages menu, unread messages are preceded by a *.

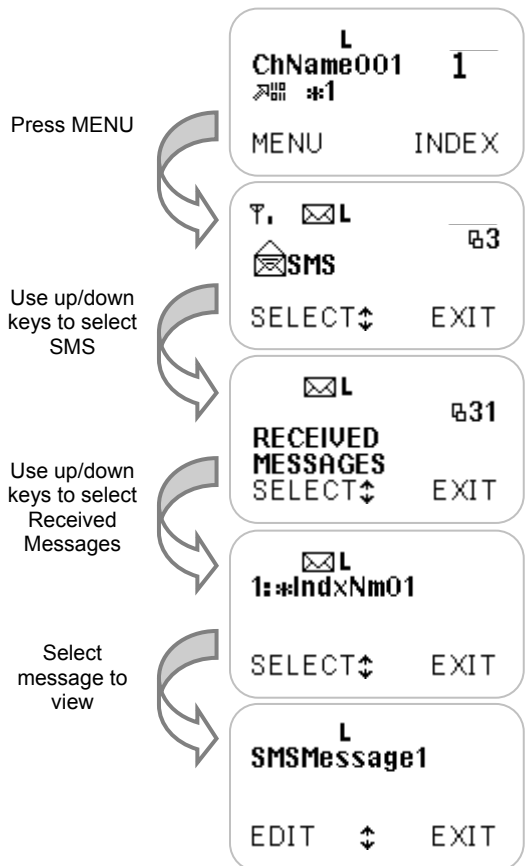

Figure 4.43 – Viewing received SMS message

4.2.9.2 Sending SMS Messages

SMS messages are sent from MENU | SMS | MSG EDIT. Use the alpha-numeric keypad to enter the desired text, then enter the destination ID or select it from the index.



Sending SMS messages may be disabled by radio programming. When SMS is disabled, SENT MESSAGES and MSG EDIT will not appear on the SMS menu. The radio will still receive SMS and you can view received messages.

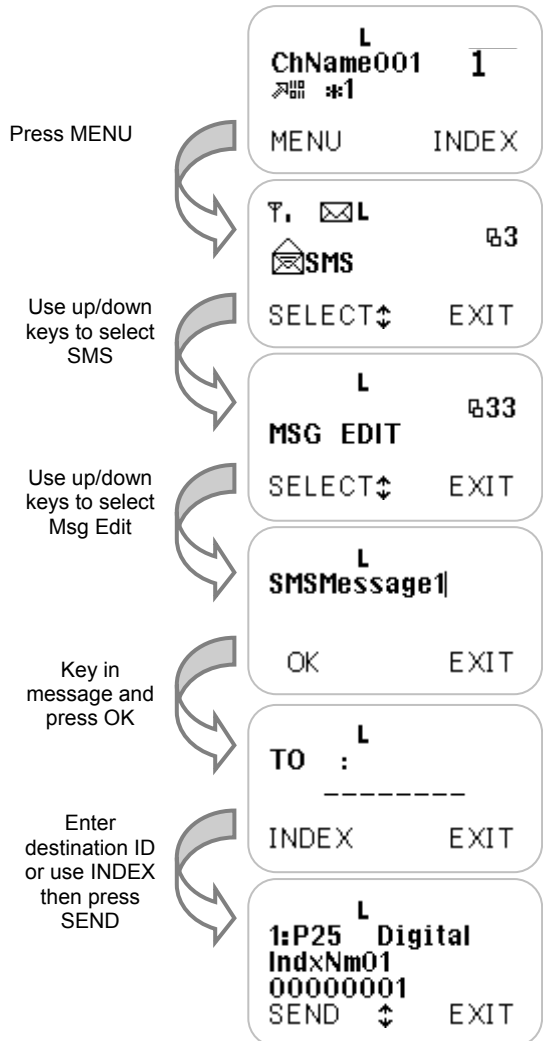

Figure 4.44 – Sending SMS message

4.2.9.3 Receiving Predefined Messages

When a predefined message is received, the corresponding text is pulled from the database and displayed along with the source ID. You may also view the last ten received predefined messages from MENU | PREDEFINED MESSAGES | RECEIVED MESSAGES.

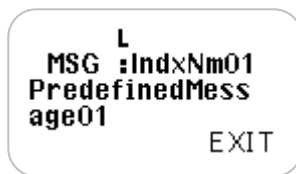

Figure 4.45 – Received predefined message

4.2.9.4 Sending Predefined Messages

Predefined messages are sent from MENU | PREDEFINED MESSAGES | MESSAGE LIST. Select the desired message from the list then enter the destination ID or select it from the index.



Sending predefined messages may be disabled in radio programming. When predefined messages are disabled, the message list may still be viewed, but predefined messages can't be sent.

Press MENU

Use up/down keys to select Predefined Messages

Use up/down keys to select Message List

Use up/down to select message and press SELECT

Enter destination ID or use INDEX then press SEND

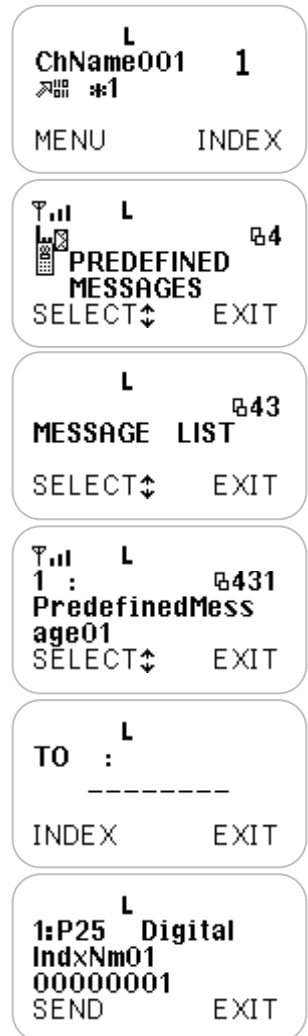

Figure 4.46 – Sending predefined message

4.2.9.5 Setting Present Status

The radio's present status may be set from MENU | STATUS | PRESENT STATUS or by pressing the Current Status Entry key

(default:  pound key) until "CUR. STATUS:" is prompted.



When the radio is turned on, the present status will be reset to the first status option in the list.

4.2.9.6 Receiving Status

When a status message is received, the corresponding text is pulled from the database and displayed along with the source ID. You may also view the last ten received status messages from MENU | STATUS | RECEIVED STATUS.

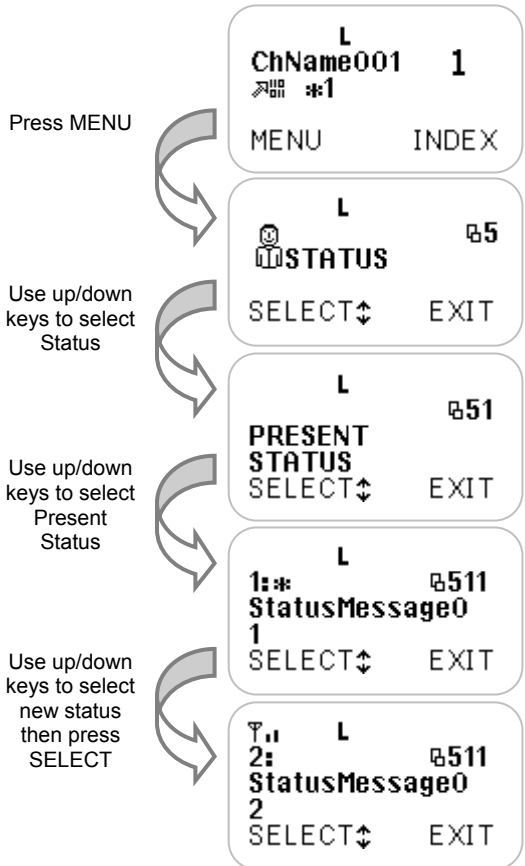

Figure 4.47 – Selecting current status



Figure 4.48 – Receiving status

4.2.9.7 Sending Status

Your current status may be sent from MENU | STATUS | SEND STATUS. Enter the destination ID or use the index to select it, then press SEND to transmit your current status.



Transmitting status may be disabled in radio programming. When status transmissions are disabled, SEND STATUS and STATUS REQUEST will not appear on the STATUS menu.

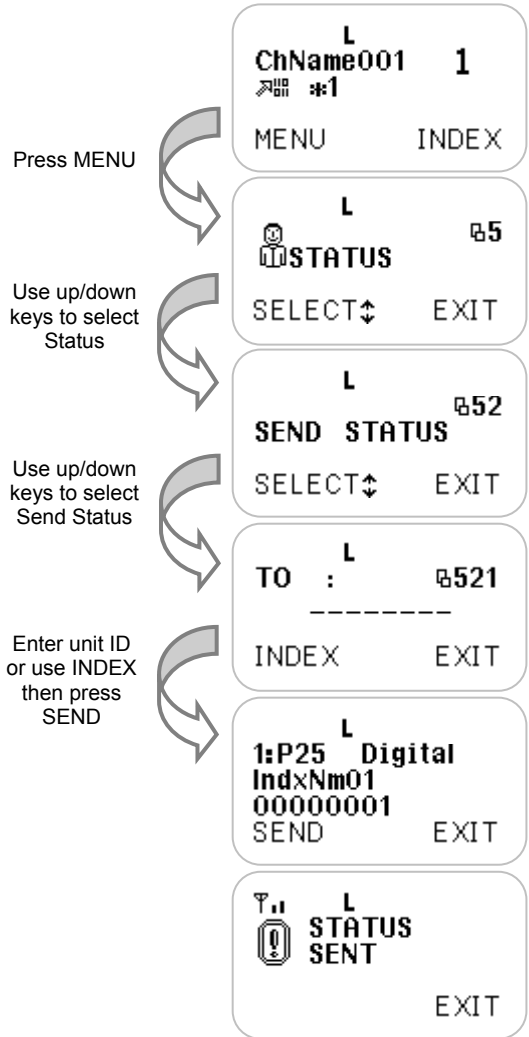

Figure 4.49 – Sending status

4.2.9.8 Requesting Status

You may request the current status of another radio from MENU | STATUS | STATUS REQUEST. Enter the destination ID or select it from the index, then press SEND to request another radio's status.



Transmitting status may be disabled in radio programming. When status transmissions are disabled, SEND STATUS and STATUS REQUEST will not appear on the STATUS menu.

Press MENU

Use up/down keys to select Status

Use up/down keys to select Status Request

Enter unit ID or use INDEX then press SEND

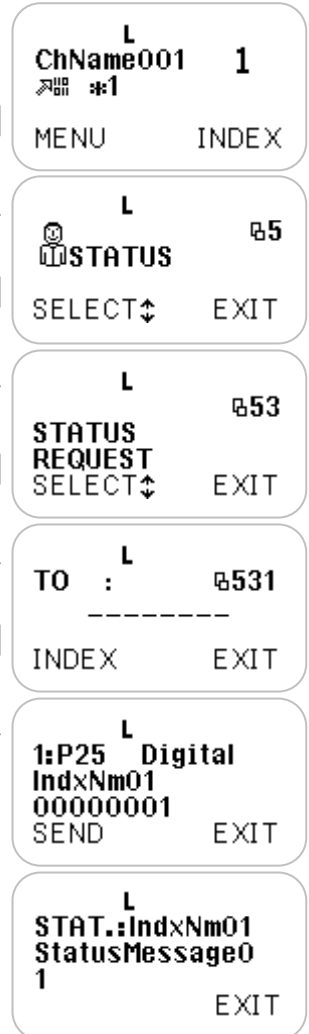

Figure 4.50 – Requesting status

4.2.10 Selecting from User Tone List

Press the User Selectable Code Entry keys (short or long press of the numeric keypad) to enter a one or two digit User Tone List selection. The name associated with the new tone/NAC selection will be briefly displayed when it is selected and when PTT is pressed. The user selected code will be utilized for the current channel until it is changed to another tone or the radio is reprogrammed. Selecting Code "0" will return the radio to the default tone/NAC selection originally programmed for the channel.

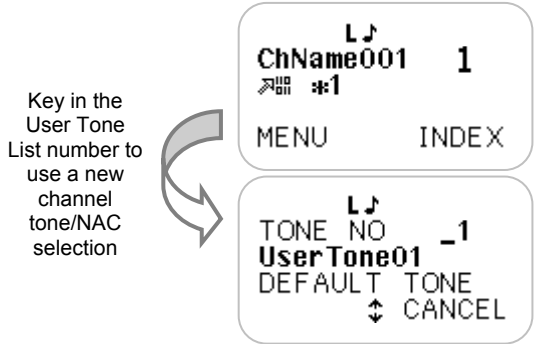

Figure 4.51 – Selecting new user tone/NAC



Figure 4.52 – Current selection displayed w/PTT

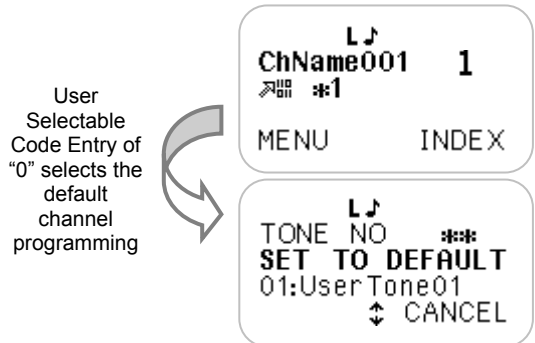

Figure 4.53 – Selecting default tone/NAC



The ability to use the User Tone List is set in radio programming on a per channel basis. Some channels may not have the User Tone List enabled.

4.2.11 Adding and Deleting from Command Zone

Press the Add/Delete from Command Zone key (default:



star key) until “Add to Command Zone?” is displayed. Then press the left soft key (OK) to add the displayed channel to the command zone. Once the command zone contains channels, it will be displayed on the zone selection list.

Channels may be removed from the command zone by selecting the desired channel in the command zone. Then press the Add/Delete from Command Zone key until “Delete from Command Zone” is displayed. Then press the left soft key (OK) to remove the channel from the command zone.

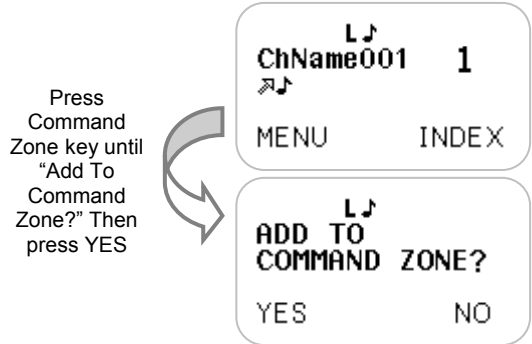

Figure 4.54 – Adding to Command Zone

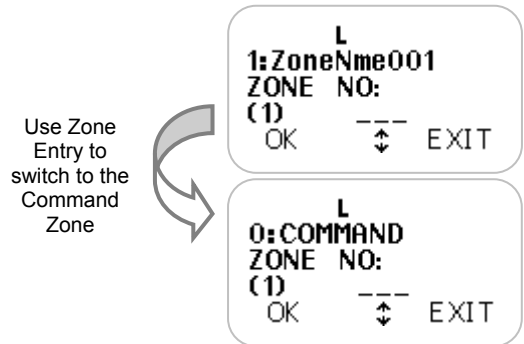

Figure 4.55 – Switching to Command Zone

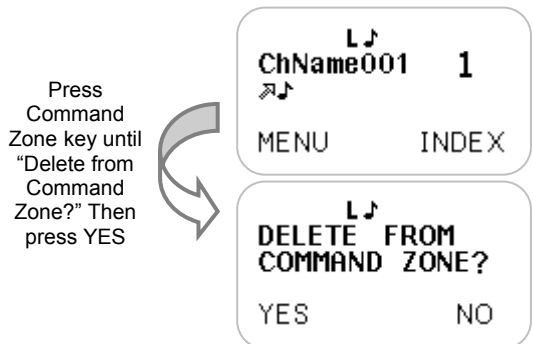

Figure 4.56 – Deleting from Command Zone

4.2.12 Channel Programming

Front panel channel programming is an option offered to some customers. Radios must be purchased with channel programming capability or returned to the factory to have the capability added.

On channel programming capable radios, the channel parameters may be edited or created from the radio's alpha-numeric keypad. Channel programming may be chosen from MENU | CHANNEL PARAMETERS | CHANNELS. Enter the channel edit password then press OK. Choose the appropriate channel then press SELECT. Then change the appropriate parameters.

The channel programming access password is set in radio programming. This password is independent of the power-on password.



Channel programming may be disabled in radio programming. When channel programming is disabled, CHANNEL will not appear on the CHANNEL PARAMETERS menu.

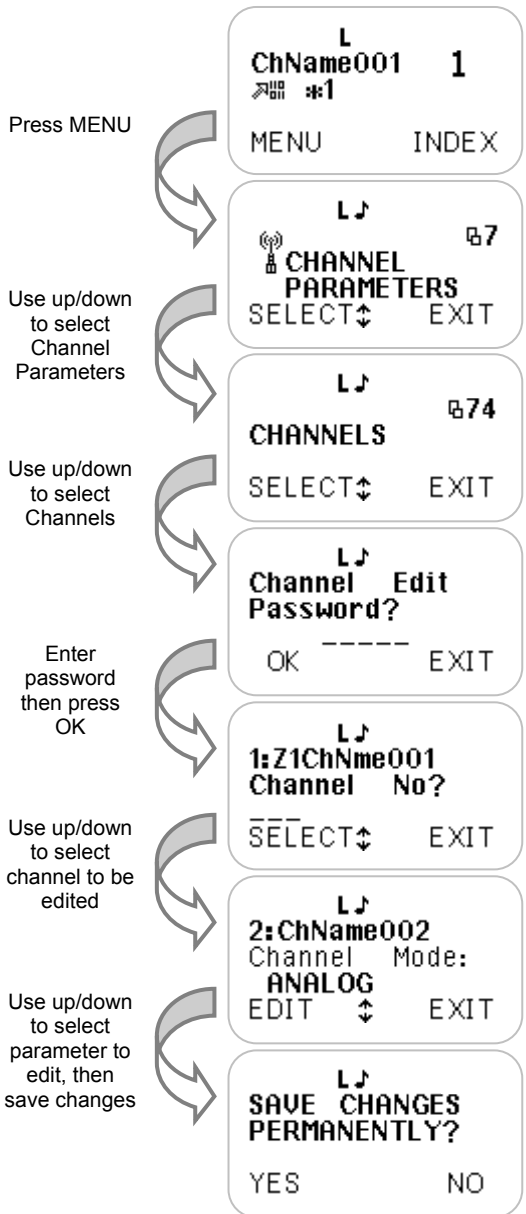
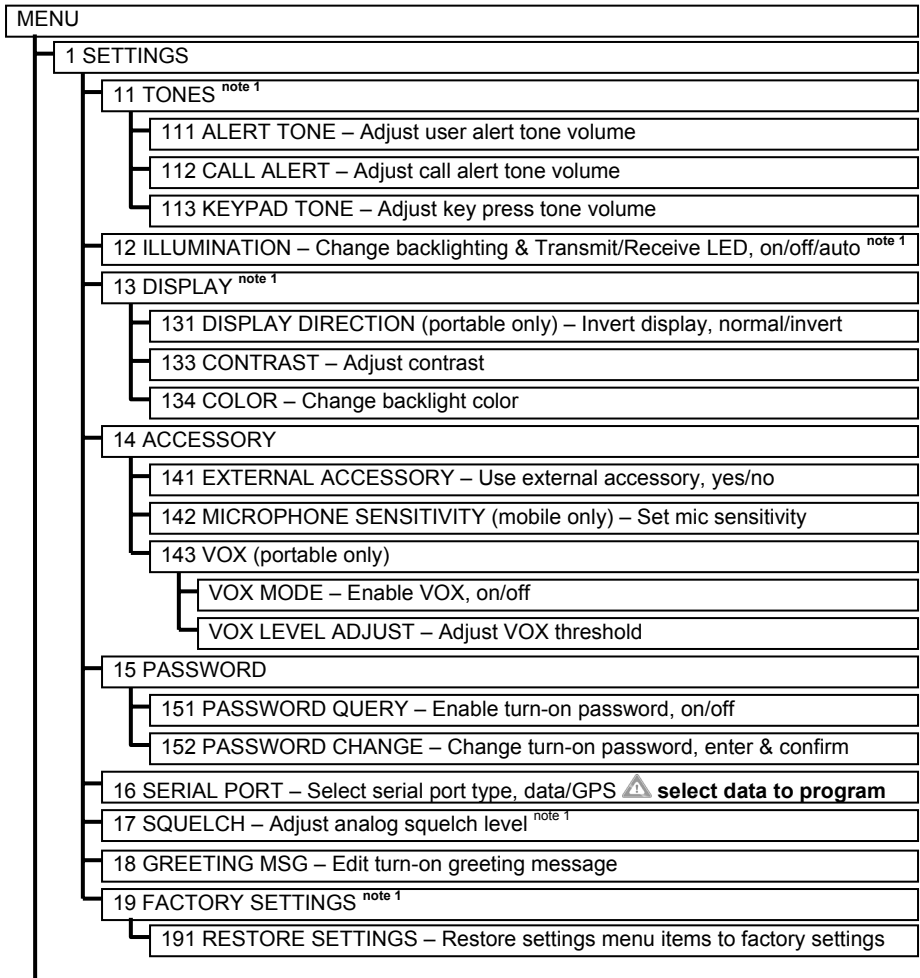

Figure 4.57 – Channel programming

4.3 Menu Operation

The menu function is used to access many features in the radio and also provides information about each radio. The features available from the menu depend on the analog/digital mode selection and the radio programming. The following menu trees depict the available menu selections, but some may not be accessible on your radio because of radio programming. The numbers shown may be used as keypad shortcuts to the menu option.

4.3.1 Analog Mode Menu Tree



6 RADIO INFO
61 IDENTS
SERIAL NO – View radio serial number
ANI, SC, ACK – View analog IDs
IDENT – View digital unit ID
RADIO NAME
TERMINAL IP-ID – View IP address
SYSTEM NO – View system ID
WACN – View wide area communication network ID
62 SOFTWARE
VERSION – View microcontroller flash version
DSP VERSION – View DSP flash version
63 HARDWARE
UNIT, RF CARD, FRONT – View PCB assembly versions
DSP, ENCRYPT, BAND – View PCB assembly & encryption versions & band
64 BATTERY INFO (portable only) (for OEM rechargeable batteries)
CHARGE, COUNT – View remaining battery capacity & charge cycle count
VOLT, CURR, TEMP – View battery voltage, current & temperature
TYPE – View battery type
65 MEASUREMENT
651 RSSI – Measure receive signal strength
652 GPS – View present GPS data
653 POWER SUPPLY – Measure supply voltage
7 CHANNEL PARAMETERS
71 CHANNEL SCAN – View & edit current zone's scan list
72 GROUPS – View & select new talk group from list
73 GROUP SCAN – Enable talk group scan (receive any talk group in list), on/off
74 CHANNELS – View & edit channel programming ^{note 6}
75 ZONES – View & select zone
76 CLONER – Clone channel parameters to another radio

4.3.2 Digital Mode Menu Tree

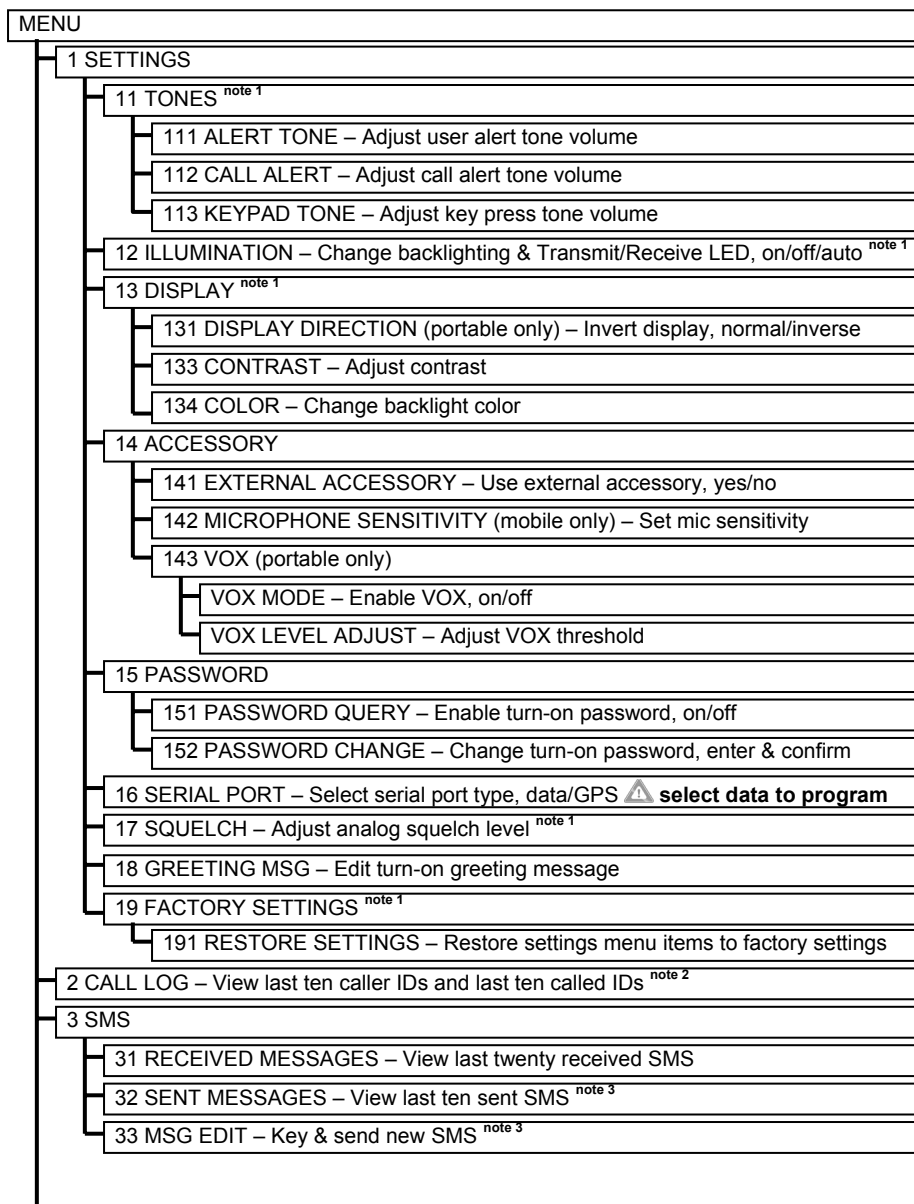

4	PREDEFINED MESSAGES
41	RECEIVED MESSAGES – View last ten received messages
42	SENT MESSAGES – View last ten sent messages ^{note 4}
43	MESSAGE LIST – View and send predefined message ^{note 4}
5	STATUS
51	PRESENT STATUS – View and set present status
52	SEND STATUS – Send present status to another radio ^{note 5}
53	STATUS REQUEST – Request another radio's present status ^{note 5}
54	RECEIVED STATUS – View last ten received status messages
6	RADIO INFO
61	IDENTS
	SERIAL NO – View electronic serial number
	ANI, SC, ACK – View analog IDs
	IDENT – View digital unit ID
	RADIO NAME
	TERMINAL IP-ID – View IP address
	SYSTEM NO – View system ID
	WACN – View wide area communication network ID
62	SOFTWARE
	VERSION – View microcontroller flash version
	DSP VERSION – View DSP flash version
63	HARDWARE
	UNIT, RF CARD, FRONT – View PCB assembly versions
	DSP, ENCRYPT, BAND – View PCB assembly & encryption versions & band
64	BATTERY INFO (portable only) (for OEM rechargeable batteries)
	CHARGE, COUNT – View remaining battery capacity & charge cycle count
	VOLT, CURR, TEMP – View batter voltage, current and temperature
	TYPE – View battery type
65	MEASUREMENT
	651 RSSI – Measure receive signal strength
	652 GPS – View present GPS data
	653 POWER SUPPLY – Measure supply voltage

7 CHANNEL PARAMETERS
71 CHANNEL SCAN – View & edit current zone’s scan list
72 GROUPS – View& select new talk group from list
73 GROUP SCAN – Enable talk group scan (recieve any talk group in list), on/off
74 CHANNELS – View & edit channel programming ^{note 6}
75 ZONES – View & select zone
76 CLONER – Clone channel parameters to another radio
8 ENCRYPTION ^{note 7}
81 ALGORITHM – View and select available encryption types
82 ENCRYPTION INFO – View encryption information, Algorithm ID and Key ID

note 1 These selections are unavailable when the *Settings* option is disabled in radio programming.

note 2 This selection is unavailable when the *Call Log* option is disabled in radio programming.

note 3 These selections are unavailable when the *SMS* option is disabled in radio programming.

note 4 These selections are limited or unavailable when the *Predefined Messages* option is disabled in radio programming.

note 5 These selections are unavailable when the *Status* option is disabled in radio programming.

note 6 This selection is unavailable when the *Channel Programming* option is disabled in radio programming.

note 7 This selection is only available when encryption option is purchased.

5 ACCESSORIES

Original Midland accessories give you operational efficiency, flexibility and reliability in difficult working conditions.

ACCESSORY	MIDLAND P/N
Microphone	ACC4425
Loudspeaker	70-2358
Under Dash Mounting Kit (Bracket w/hardware)	560-090-0091
50W Trunk Mounting Kit (w/90-0075)	90-2578
50W Trunk Mount Power Cable	90-0042
50W Trunk Mount Control Cable	90-0075
110W Trunk Mount Power Cable	90-0045
110W Trunk Mount Bracket	90-2291
110W Trunk Mount Control Cable	90-0075
Ignition Sense Kit	90-2271
Programming Software	MRP P25
Programming Cable	ACC2600
Cloning Adapter (Requires two ACC2600)	ACC2305

6 STORAGE AND CLEANING PRECAUTIONS



Keep the radio clean and away from dust, humidity, dense sunlight, extreme heat sources and liquids.



Avoid exposing the radio and accessories to cleaning solvents, aerosol sprays, adhesive agents, paints etc. Chemical reactions with such agents will destroy seals, case, display and finish.



If the radio is exposed to dirt, wipe with a soft and moist cloth at least once a week to prevent build-up of dirt and dust deposits.



Your radio does not require any periodic maintenance.

7 TROUBLESHOOTING

PROBLEM	POSSIBLE CAUSE(s)	SOLUTION(s)
No display on LCD when radio is turned on.	Fuse is blown or connections are insecure.	Check fuse and connections.
No sound from Loudspeaker.	Volume level is too low. or Squelch level is too high. or Radio is set for external accessory.	Adjust volume level. or Adjust squelch level. or Turn off external accessory. or Check speaker connections.
No response to key press.	Key lock is on.	Unlock the keypad.
No answer to calls.	Out of range of other stations or signal is blocked by terrain.	Switch to high output power. or Move closer until you have a "line-of-sight" to the other station.
Radio to PC connection fails.	Serial port is set for GPS receiver.	Change serial port selection to "DATA".

8 SPECIFICATIONS

GENERAL SPECIFICATIONS	
Modulation	16K0F3E, 11K0F3E, 8K0D1E, 8K0F1E
Data Rate	P25 : 9.6 kb/s
Symbol Rate	P25 : 4.8 kb/s
Protocol	Project 25-CAI : 4.4 kb/s IMBE
Encryption Algorithms	DES-OFB, AES
Channel Capacity	999
Operating Voltage Range	13.6 Vdc \pm % 20 (10.88-16.32 Vdc)
Standby Current Drain (backlight off)	\leq 0.4 A
RX Current Drain	\leq 1.5
TX Current Drain	\leq 8.5 A
Display	64x128 pixel LCD
Keypad	20 key, back lit
Dimensions (HxWxL) (projections not included)	1.8x6.5x6.5 in (46x165x165 mm)
Weight	1.50 kg

ENVIROMENTAL SPECIFICATIONS	
Operating Temperature Range	-30°C / +60°C
Storage Temperature Range	-40°C / +85°C
Humidity	% 95, 50°C
ESD	IEC 801- 2KV
Water and Dust Protection	IP65, MIL-STD

MILITARY STANDARDS 810C/D/E/F								
	MIL-STD 810C		MIL-STD 810D		MIL-STD 810E		MIL-STD 810F	
	Method	Proc./ Cat.	Method	Proc./ Cat.	Method	Proc./ Cat.	Method	Proc./ Cat.
Low Pressure	500.1	I	500.2	II	500.3	II	500.4	II
High Temperature	501.1	I, II	501.2	I/A1, II/A1	501.3	I/A1, II/A1	501.4	I/Hot, II/Hot
Low Temperature	502.1	I	502.2	I/C1, II/C2	502.3	I/C1, II/C2	502.4	I/C1, II/C2
Temperature Shock	503.1	–	503.2	I/A1-C2	503.3	I/A1-C2	503.4	I/Hot-C2
Solar Radiation	505.1	II	505.2	I	505.3	I	505.4	I
Rain	506.1	I, II	506.2	I, II	506.3	I, II	506.4	I, III
Humidity	507.1	II	507.2	II	507.3	II	507.4	–
Salt Fog	509.1	–	509.2	–	509.3	–	509.4	–
Sand and Dust	510.1	I	510.2	I, II	510.3	I, II	510.4	I, II
Vibration	514.2	VIII/F, XI/H	514.3	I/10, II/3	514.4	I/10, II/3	514.5	I/24, II/5
Shock	516.2	I, II, V	516.3	I, V, VI	516.4	I, V, VI	516.5	I, V, VI

8.1 Receiver Technical Specifications

RECEIVER SPECIFICATIONS		
	VHF	UHF
Frequency Range	136-174 MHz	380-470 MHz
Frequency Separation	Full Bandsplit	Full Bandsplit
Channel Spacing	12.5 / 20 / 25 / 30 kHz	12.5 / 20 / 25 / 30 kHz
Frequency Step	2.5 / 3.125 kHz	2.5 / 3.125 kHz
Rated Audio Output Power *	10 W / 4 Ω	10 W / 4 Ω
Frequency Stability * (-30°C / +60°C; 25°C ref)	± 2.5 ppm	± 1.5 ppm
Analog Sensitivity *		
12 dB SINAD	≤ -119 dBm	≤ -118 dBm
Digital Sensitivity **		
5% BER	≤ -120 dBm	≤ -119 dBm
1% BER	≤ -117 dBm	≤ -116 dBm
Adjacent Channel Rejection		
Analog 25 kHz channel *	≥ 75 dB	≥ 75 dB
Analog 12.5 kHz channel *	≥ 63 dB	≥ 63 dB
Digital 12.5 kHz channel **	≥ 63 dB	≥ 63 dB
Intermodulation Rejection *	≥ 75 dB	≥ 75 dB
Spurious Response Rejection*	≥ 85 dB	≥ 85 dB
Hum and Noise Ratio		
Analog 25 kHz channel *	≥ 48 dB	≥ 42 dB
Analog 12.5 kHz channel *	≥ 42 dB	≥ 36 dB
Digital 12.5 kHz channel **	≥ 50 dB	≥ 50 dB
Audio Distortion *	≤ 3 %	≤ 3 %

* Measured in the analog mode per EIA-603 under nominal conditions.

** Measured in the digital mode per TIA-102.CAAA under nominal conditions.

8.2 Transmitter Technical Specifications

TRANSMITTER SPECIFICATIONS		
	VHF	UHF
Frequency Range	136-174 MHz	380-470 MHz
Frequency Separation	Full Bandsplit	Full Bandsplit
Channel Spacing	12.5 / 20 / 25 / 30 kHz	12.5 / 20 / 25 / 30 kHz
Frequency Step	2.5 / 3.125 kHz	2.5 / 3.125 kHz
Rated RF Output Power *	5-50 W / 10-110 W	5-40 W
Frequency Stability * (-30°C / +60°C; 25°C ref)	± 2.5 ppm	± 1.5 ppm
Modulation Limiting *		
Analog 25 kHz channel	± 5.0 kHz	± 5.0 kHz
Analog 12.5 kHz channel	± 2.5 kHz	± 2.5 kHz
C4FM Modulation Fidelity **		
RMS Error	≤ 2 %	≤ 2 %
C4FM Deviation	1800 ±100 Hz	1800 ±100 Hz
Spurious Emissions * (Conducted and Radiated)	≤ -70 dBc	≤ -70 dBc
Audio Frequency Response * (6 dB/Octave Pre-emphasis from 300 to 3000 Hz)	+1, -3 dB	+1, -3 dB
Hum and Noise Ratio		
Analog 25 kHz channel *	≥ 52 dB	≥ 46 dB
Analog 12.5 kHz channel *	≥ 46 dB	≥ 40 dB
Audio Distortion *	≤ 1 %	≤ 1 %

* Measured in the analog mode per EIA-603 under nominal conditions.

** Measured in the digital mode per TIA-102.CAAA under nominal conditions.

9 WARRANTY STATEMENT

Midland Radio Corporation (herein, Midland) warrants each new radio product manufactured or supplied by it to be free from defects in material and workmanship under normal use and service for a period listed below, provided that the user has complied with the requirements stated herein.

The Warranty period begins on the date of purchase from an Authorized Midland Sales and Service Outlet. This Warranty is offered to the original end user and is not assignable or transferable. Midland is not responsible for any ancillary equipment attached to or used in conjunction with Midland products.

Midland offers to the original end user a Two (2) Year Limited Warranty on Midland Business and Industrial radio products. Accessories carry a One (1) Year Limited Warranty.

During this period, if the product fails to function under normal use because of manufacturing defect(s) or workmanship, it should be returned to the Authorized Midland Sales and Service Outlet from which it was purchased. The Sales and Service Outlet will repair the product or return the product for repair to Midland or its Authorized Repair Depot. The user is responsible for the payment of any charges or expenses incurred for the removal of the defective product from the vehicle or other site of its use; for the transportation of the product to the Sales and Service Outlet; for the return of the repaired / replacement product to the site of its use and for the reinstallation of the product.

Midland shall have no obligation to make repairs or to cause replacement required, which results from normal wear and tear or is necessitated in whole or in part by catastrophe, fault or negligence of the user, improper or unauthorized alterations or repairs to the Product, incorrect wiring, use of the Product in a manner for which it was not designed or by causes external to the Product. This Warranty is void if the product serial number is altered, defaced or removed.

Midland's sole obligation hereunder shall be to replace or repair the Product covered in this Warranty. Replacement, at Midland's option, may include a similar or higher-featured product. Repair may include the replacement of parts or boards with functionally equivalent reconditioned or new parts or boards. Replaced parts, accessories, batteries or boards are warranted for the balance of the original time period. All replaced parts, accessories, batteries or boards become the property of Midland.

THE EXPRESS WARRANTIES CONTAINED HEREIN ARE IN LIEU OF ALL OTHER WARRANTIES, EITHER EXPRESSED OR IMPLIED OR STATUTORY, INCLUDING, WITHOUT LIMITATION, ANY WARRANTY OF MERCHANTABILITY OR FITNESS FOR A PARTICULAR PURPOSE.

FOR ANY PRODUCT WHICH DOES NOT COMPLY WITH THE WARRANTY SPECIFIED, THE SOLE REMEDY WILL BE REPAIR OR REPLACEMENT. IN NO EVENT WILL MIDLAND BE LIABLE TO THE BUYER OR ITS CUSTOMERS FOR ANY DAMAGES, INCLUDING ANY SPECIAL, INCIDENTAL, INDIRECT OR CONSEQUENTIAL DAMAGES, OR FOR THE LOSS OF PROFIT, REVENUE OR DATA ARISING OUT OF THE USE OF OR THE INABILITY TO USE THE PRODUCT.

This warranty is void for sales and deliveries outside of the U. S. A. and Canada.



5900 Parretta Drive
Kansas City, MO. 64120
<http://www.Midlandradio.com>